

Solar Impact Sensor

QLS60

- Sensor for acquiring the impact of solar radiation
- Output signal DC 0...10 V
- 2-wire current output 4...20 mA

Use

The solar impact sensor is used as a reference sensor in heating, ventilation and air conditioning plants where compensation of solar radiation is required. Solar compensation is necessary where buildings or building sections with large window areas are subjected to strong solar radiation, especially in plants where thermostatic radiator valves cannot be used.

Ordering

When ordering, please give name and type reference: Solar impact sensor **QLS60**

Equipment combinations

The sensor can be used in connection with all types of systems and devices capable of acquiring and handling the sensor's 4...20 mA or DC 0...10 V output signal.

Technical design

To determine the impact of solar radiation, the sensor uses a solar cell which acquires the level of radiation. That cell generates an electrical current depending on the extent of radiation, which is then evaluated by the sensor. As a result, the sensor delivers an output signal of 4...20 mA or DC 0...10 V, which is proportional to the solar radiation range.

The solar impact sensor is designed for wall mounting. The cable must be introduced from the bottom.

The sensor consists of plastic housing with a transparent cover and a Pg 9 cable entry gland.

The solar cell is located in the cover, the sensor electronics with the connection terminals inside the housing. The cover is secured to the housing with 2 screws and can be removed. A rubber seal is used between housing and cover to ensure degree of protection IP 65. The measured values from the photocell to the sensor electronics are transmitted via a 2-wire connection.

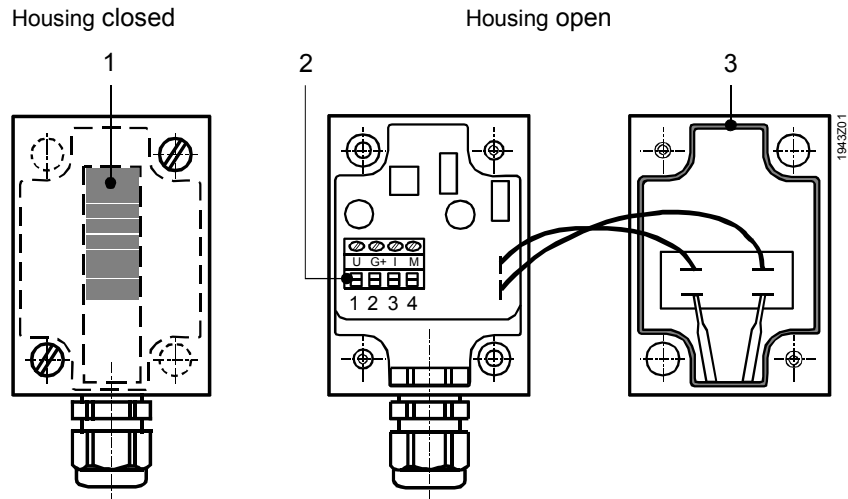

Legend

- 1 Solar cell
- 2 Connection terminals
- 3 Rubber seal

Engineering notes

The correct mounting location of the sensor is decisive for achieving the desired effect. It must be determined by the planning engineer. The information given in section "Mounting and installation notes" must be observed.

Power supply line and measuring line must be run together.

The voltage output can be used only if the current output is not required. Mixed operation is not possible. The measuring voltage is calculated as follows:

$$U = E \cdot \frac{10 \text{ V}}{1000 \text{ W / m}^2}$$

where E = solar radiation in W/m²

When using the current output, the voltage output cannot be used. The electronic circuit receives its power from the current supply. For that, the current measuring voltage must lie in the range of DC 15...30 V. The measuring current is calculated as follows:

$$I = 4 \text{ mA} + E \cdot \frac{16 \text{ mA}}{1000 \text{ W / m}^2}$$

where E = solar radiation in W/m²

Fitting and installation notes

When deciding on the mounting location, it should first be determined for which part of the building (heating zone) the sensor shall acquire the solar radiation. It must be located on the wall having the windows of the rooms that are affected by solar radiation. This is, in general:

- The wall of the heating zone with the window area which receives the largest part of solar radiation for the longest period of time
- As high as possible, but at least 3 m above the ground
- Easily accessible (to facilitate checking), approximately 30 cm beside a window

Note:

Not in the shade of trees, houses, telephone poles, etc.

The sensor must not be painted over.

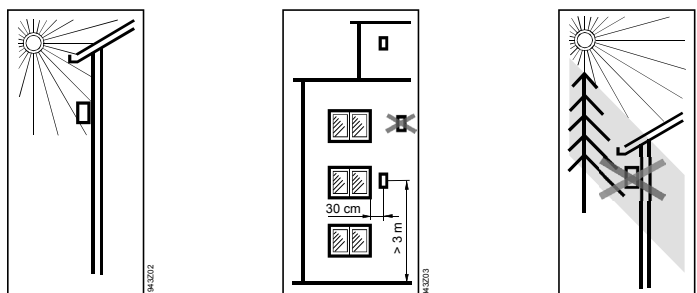

The solar impact sensor is supplied complete with Mounting Instructions.

Commissioning notes

When commissioning the plant, the wiring must be checked. No settings can be made on the sensor itself.

Disposal notes

Larger plastic parts carry material identifications conforming to ISO/DIS 11 469 to facilitate environment-compatible disposal.

Technical data

| | | | |
|-------------------------------|---------------------------------------|---|--------------|
| Power supply (G+, M) | Rated voltage range | AC 24 V \pm 20 % (SELV) or DC 24 V (18...30 V) | |
| | Rated frequency at AC 24 V | 50/60 Hz | |
| | Rated power consumption | max. 2.5 VA (1 W) | |
| Range of use | Measuring range | 0...1000 W/m ² | |
| Functional data | Time constant t_{63} | \leq 2 s | |
| Measured value outputs (U, I) | Voltage signal output (U) | DC 0...10 V \cong 0...1000 W/m ² | |
| | Current signal output (I) | 4...20 mA \cong 0...1000 W/m ² | |
| | Perm. cable lengths with copper cable | 1.0 mm ² | 50 m |
| | | 1.5 mm ² | 150 m |
| 2.5 mm ² | | 300 m | |
| Electrical connections | Screw terminals for | 2 x 1.5 mm ² or 1 x 2.5 mm ² | |
| Protective data | Degree of protection of housing | IP 65 to IEC 60 529 | |
| | Insulation class | III to EN 60 730 | |
| Environmental conditions | Operation to | IEC 60 721-3-3 | |
| | | Climatic conditions | Class 3K5 |
| | | Temperature | -25...+55 °C |
| | Humidity (noncondensing) | 5...95 % r. h. | |
| | Mechanical conditions | Class 3M2 | |
| | Transportation to | IEC 721-3-2 | |
| | | Climatic conditions | Class 2K3 |
| | | Temperature | -25...+70 °C |
| Humidity | <95 % r. h. | | |
| Mechanical conditions | Class 2M2 | | |

| | | |
|----------------------|---|---|
| Norms and standards | Electromagnetic compatibility Immunity Emissions CE conformity to EMC directive | EN 61 326 Class B to EN 61 326 89/336/EEC |
| Materials and colors | Housing Housing cover Packaging | Polycarbonate / RAL 9002 (gray-white) Polycarbonate (transparent) cardboard |
| Weight | Without packaging | approx. 0.102 kg |

Connection diagrams

Internal diagrams

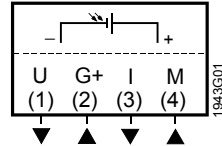

G+ Operating voltage AC 24 V or DC 24 V (DC 18...30 V)
M Measuring neutral (power supply and signal)
U Solar radiation measuring signal DC 0...10 V
I Solar radiation measuring signal 4...20 mA

Connection diagrams

Voltage measurement with
AC supply:

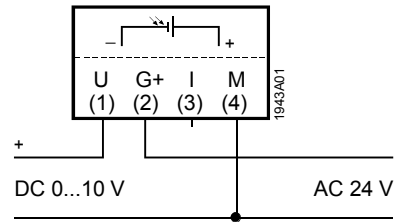

DC supply:

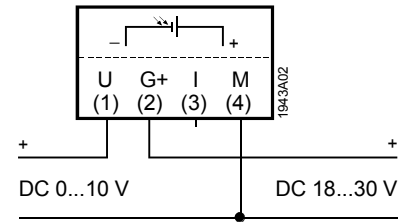

Current measurement with own power generation:

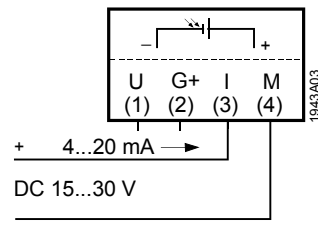

Dimensions

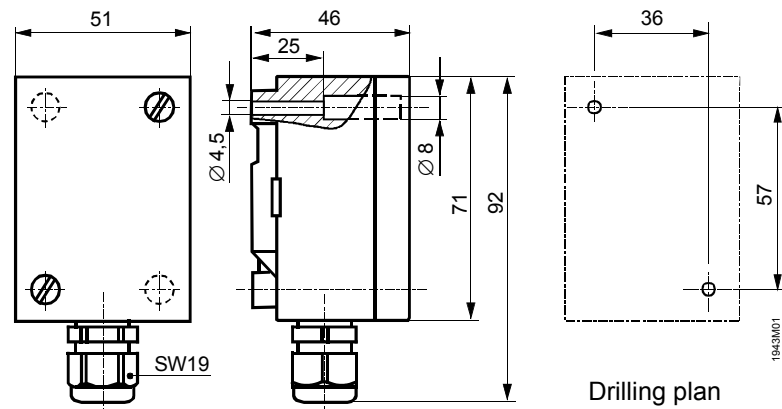

Dimensions in mm