



Siebe Environmental Controls
 1354 Clifford Avenue (Zip 61111)
 P.O. Box 2940
 Loves Park, IL 61132-2940
 United States of America

An Invensys company

MN-S1, MN-S2, MN-S3 MN-S4, MN-S4-FCS, and MN-S5

I/A Series[®] MicroNet Sensors General Instructions

Application

I/A Series MicroNet Sensors are wall-mounted digital temperature sensors for use with I/A Series MicroNet Controllers. These sensors feature Sensor Link (S-LK) communication protocol which provides a simple two wire interface for power and exchange of sensor and subbase information. Available in six models, these I/A Series MicroNet Sensors provide integral analog to digital conversion for elimination of electrical interference between sensor and controller. An optional wiring connection allows access to the MicroNet LONWORKS network (LON) via a LON jack on the left side of each controller.

I/A Series MicroNet Sensors are suitable for direct-wall, 2 x 4 electrical box, 1/4 DIN electrical box, or surface box mounting.

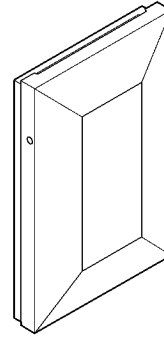

MN-S1

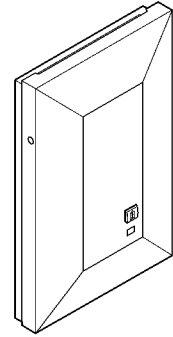

MN-S2

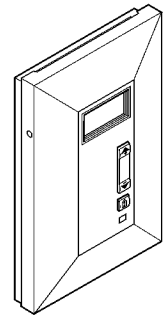

MN-S3

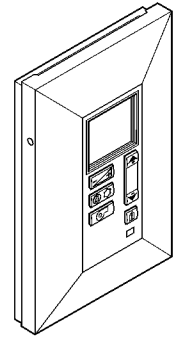

MN-S4

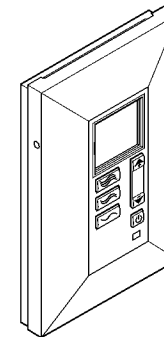

MN-S4-FCS

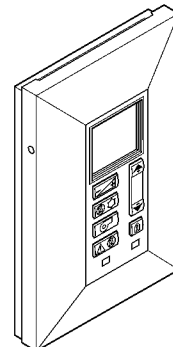

MN-S5

Model Chart

Model	Description	Keypad	Display
MN-S1	Sensor Only	None	None
MN-S2	Sensor with Override	One-key	LED Override Status Indication
MN-S3	Sensor with Setpoint Adjustment and Override	Three-key	LED Override Status Indication and Digital LCD ^a
MN-S4	Sensor with Setpoint, Override, and Controller mode Functions	Six-key	LED Override Status Indication and Digital LCD ^b
MN-S4-FCS	Sensor with Single Setpoint, On/Off, and Fan Speed Functions	Six-key	LED Status Indication, Digital LCD
MN-S5	Sensor with Setpoint, Override, Controller Mode Functions, and Emergency Heat Key/Indication	Seven-key	LED Override Status Indication, Digital LCD ^b , and LED Emergency Heat Status Indication

^aLCD displays single value and setpoint.

^bLCD displays values, setpoints, and controller mode functions.



hvacUSA.com
 A MechTronics Controls Company
www.hvacusa.com
 Phone (877) 632-4876

Applicable Documentation

F-Number	Description	Audience	Purpose
F-26266	I/A Series MicroNet LONMARK 100, 150, and 200 Series Controllers Installation Instructions	<ul style="list-style-type: none"> – Application Engineers – Installers – Service Personnel – Start-up Technicians 	Provides step-by-step mounting and installation instructions for the I/A Series MicroNet LONMARK 100, 150, and 200 Series Controllers. Also includes checkout and LED indication sections.
F-26617	I/A Series MicroNet LONMARK 50 Series Controllers Installation Instructions	<ul style="list-style-type: none"> – Application Engineers – Installers – Service Personnel – Start-up Technicians 	Provides step-by-step mounting and installation instructions for the I/A Series MicroNet LONMARK 50 Series Controller. Also includes checkout and LED indication sections.
F-26282	I/A Series MicroNet LONMARK VAV Series (MNL-V1RVX and MNL-V2RVX) Controllers Installation Instructions	<ul style="list-style-type: none"> – Application Engineers – Installers – Service Personnel – Start-up Technicians 	Provides step-by-step mounting and installation instructions for the I/A Series MicroNet LONMARK MNL-V1RVX and MNL-V2RVX VAV Controllers. Also includes checkout and LED indication sections.
F-26284	I/A Series MicroNet LONMARK VAV Series (MNL-V3RVX) Controller Installation Instructions	<ul style="list-style-type: none"> – Application Engineers – Installers – Service Personnel – Start-up Technicians 	Provides step-by-step mounting and installation instructions for the I/A Series MicroNet LONMARK MNL-V3RVX VAV Controller. Also includes checkout and LED indication sections.
F-26303	I/A Series MicroNet System Overview	<ul style="list-style-type: none"> – Application engineers – Installers – Start-up technicians – Service personnel 	Provides an overview of the I/A Series MicroNet System. It includes brief descriptions of the hardware and software components, and how they may be combined to create MicroNet networks and stand-alone systems.
F-26580	Work Place Tech Tool Engineering Guide	<ul style="list-style-type: none"> – Application Engineers – Installers – Service Personnel – Start-up Technicians 	Provides engineering and technical information for applying and using all aspects of Work Place Tech Tool.
F-26507	I/A Series MicroNet System Engineering Guide	<ul style="list-style-type: none"> – Application Engineers – Installers – Service Personnel – Start-up Technicians 	Provides engineering and technical information to assist in designing a complete MicroNet controller system using different architectures, components, and software.
F-26304	Work Place Tech Tool User's Guide	<ul style="list-style-type: none"> – Application Engineers – Installers – Service Personnel – Start-up Technicians 	Provides step-by-step instructions for using Work Place Tech Tool.

Installation

The I/A Series MicroNet Sensor is packaged disassembled in one container and consists of three major parts:

- A pre-wirable base plate for wiring to the controller S-LK and MicroNet LONWORKS network (LON) connections
- An electronic assembly containing the sensor and associated circuitry
- A removable cover

Inspection

Inspect carton for damage. If damaged, notify carrier immediately. Inspect sensors for damage. Return damaged products.

Requirements

(These items not provided)

- Installer must be a qualified technician.
- Job wiring diagrams
- Tools:
 - Drill and bits for mounting screws
 - Level
 - Static protection wrist strap
- Two mounting screws (dry-wall anchors for direct-wall mount)
- Accessories (if required)
 - AT-1104 Cast aluminum guard with steel base plate
 - AT-1155 Clear plastic guard with solid and ring base, tumbler type key lock
 - AT-1163 Wire guard with steel base plate
 - MNA-STAT-1 Replacement covers (qty. 12)
 - MNA-STAT-2 Designer inserts for MN-S1 model (qty. 25)

Precautions



General

Warning: Electrical shock hazard! Disconnect power before installing or removing the cover.

- Follow Static precautions when installing this equipment.
- Use copper conductors that are suitable for 167°F (75°C).
- Make all connections according to electrical wiring diagram, national and local electrical codes.

Static Precautions

Static charges damage electronic components. The microprocessor and associated circuitry are extremely sensitive to static discharge. Use the following precautions when installing, servicing, or operating the system.

- Work in a static-free area.
- Discharge static electricity by touching a known, securely grounded object.
- Use a wrist strap connected to earth ground when handling the controller's printed circuit board.

Federal Communications Commission (FCC)

This equipment has been tested and found to comply with the limits for a Class B digital device, pursuant to Part 15 of the FCC Rules. These limits are designed to provide reasonable protection against harmful interference in residential installations. This equipment generates, uses, and can radiate radio frequency energy and may cause harmful interference if not installed and used in accordance with the instructions. Even when instructions are followed, there is no guarantee that interference will not occur in a particular installation. If this equipment causes harmful interference to radio or television reception—which can be determined by turning the equipment off and on—the user is encouraged to try to correct the interference by one or more of the following measures:

- Reorient or relocate the receiving antenna.
- Increase the separation between the equipment and receiver.
- Connect the equipment to an outlet on a circuit different from that to which the receiver is connected.
- Consult the dealer or an experienced radio/television technician for help.

Canadian Department of Communications (DOC)

This class B digital apparatus meets all requirements of the Canadian Interference-Causing Equipment Regulations.

Location

I/A Series MN-S1 through MN-S5 MicroNet Sensors are suitable for indoor use only.

Caution:

- Avoid locations where excessive moisture, corrosive fumes, vibration, or explosive vapors are present.
 - Avoid electrical noise interference. Do not install near large contactors, electrical machinery, or welding equipment.
 - Locate where ambient temperatures do not exceed 122°F (50°C) or fall below 32°F (0°C) and relative humidity does not exceed 95% or fall below 5%, non-condensing.
-

Locate the I/A Series MicroNet Sensor on an inside wall where the sensor is exposed to at least 30 feet (9 meters) per minute of unrestricted air circulation. The location should represent the average temperature in the room or space. Make certain sensor is located out of direct sunlight, away from sources of heat or cold, and away from concealed ducts or pipes.

Mounting

I/A Series MicroNet Sensors can be direct-wall, 2 x 4 electrical box, 1/4 DIN electrical box, or surface box mounted. See Figure-1 and Figure-2 for appropriate mounting dimensions.

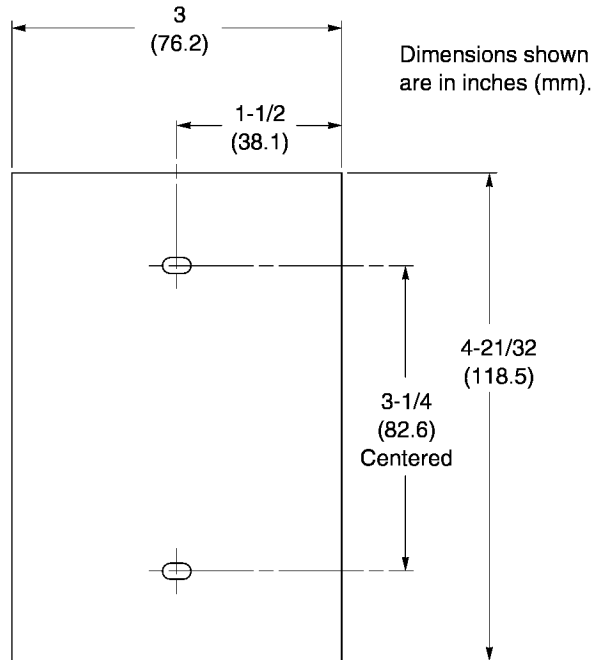

Figure-1 Mounting Dimensions for Direct-wall, 2 x 4 Electrical Box, and Surface Box Mounting.

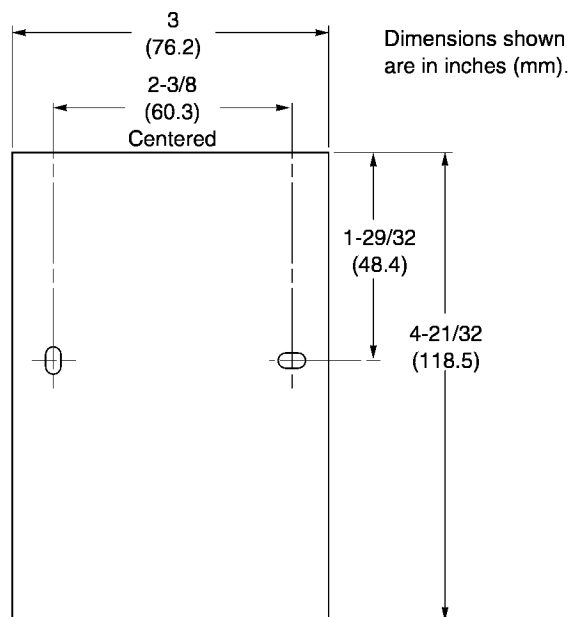

Figure-2 Mounting Dimensions for 1/4 DIN Electrical Box Mounting.

Direct-wall Mount

1. Use mounting dimensions shown in Figure-1.
2. Feed S-LK wires through base plate.
3. If required, feed LON wires through base plate.
4. Using two appropriate screws (use drywall anchors as necessary), mount base plate to wall (Figure-3).

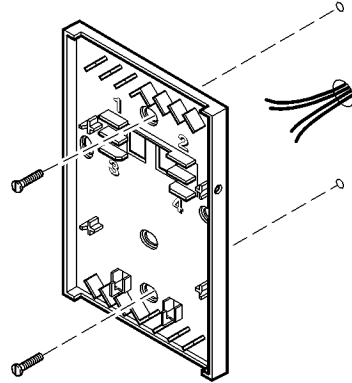

Figure-3 Direct-wall Mounting.

2 x 4 Electrical Box Mount

1. Use mounting dimensions shown in Figure-1.
2. Feed S-LK wires from electrical box through base plate.
3. If required, feed LON wires through base plate.
4. Using two 6-32 x 5/8 in. flat head screws (not provided), mount base plate to electrical box (Figure-4).

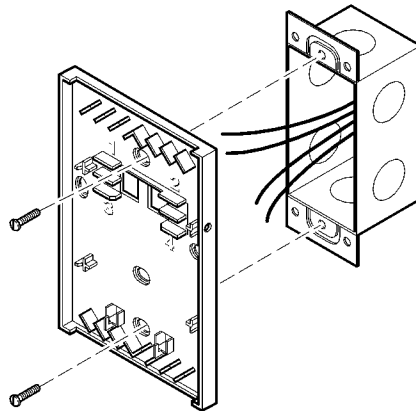

Figure-4 2 x 4 Electrical Box Mounting.

1/4 DIN Electrical Box Mount

1. Use mounting dimensions shown in Figure-2.
2. Feed S-LK wires from electrical box through base plate.
3. If required, feed LON wires through base plate.

Caution: Failure to use vertical mounting holes as shown in Figure-5 may cause a short of the LON.

4. Using two appropriate screws (not provided), mount base plate to electrical box using vertical mounting holes indicated in Figure-5.

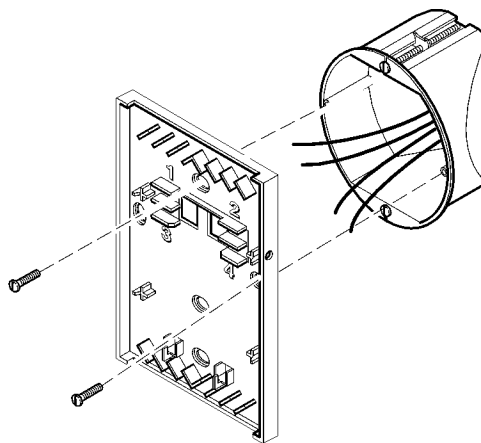

Figure-5 1/4 DIN Electrical Box Mounting.

Surface Box Mount

1. Use mounting dimensions shown in Figure-1.
2. Feed S-LK wires from electrical box through base plate.
3. If required, feed LON wires through base plate.
4. Using two 6-32 x 5/8 in. flat head screws (not provided), mount base plate to surface box (Figure-6)

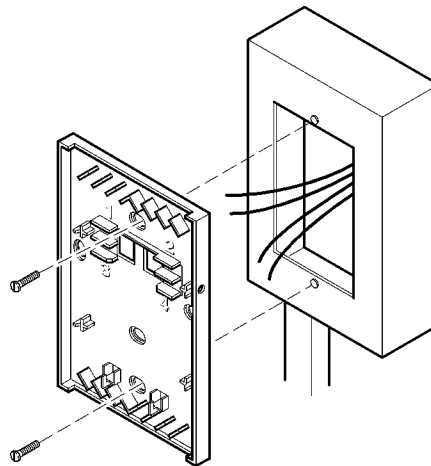

Figure-6 Surface Box Mounting.

Wiring

The following electrical connections can be made to the I/A Series MicroNet Sensors:

- Sensor Link (S-LK) Wiring
- MicroNet LonWorks network (LON) Wiring

Communications Wiring

Caution:

- Communication wire pairs must be dedicated to S-LK and MicroNet LONWORKS network (LON) communications. They cannot be part of an active, bundled telephone trunk.
 - Shielded cable is not required for S-LK or LON wiring.
 - If the cable is installed in areas of high RF/EMI, the cable must be in conduit.
 - Do not mix with UI, DI, AO, DO, or power types of wiring. If conduit is used between an I/A Series Sensor and a controller, LON wiring and S-LK wiring can be in the same conduit.
 - If shielded wire is used for LON, the shield must be connected to earth ground at one end only by a 470K ohm 1/4 watt resistor. Shield must be continuous from one end of the trunk to the other.
-

Communications wiring includes a connection between the controller and an I/A Series MicroNet Sensor via the S-LK and an optional connection between the sensor and the MicroNet LONWORKS network (LON). Figure-7 shows S-LK and LON wiring terminations.

Sensor Link (S-LK) Wiring

S-LK wiring powers and enables the MN-SX sensor. The S-LK needs at least 24 gage (0.51mm), twisted pair, voice grade telephone wire. The capacitance between conductors cannot be more than 32 pF per foot (0.3m). If shielded cable is used, the capacitance between any one conductor and the others, connected to the shield, cannot be more than 60 pF per foot (0.3m). Maximum wire length is 200 ft. (61m).

Note:

- S-LK wiring is polarity insensitive.
 - If conduit is used between an I/A Series Sensor and a controller, the MicroNet LONWORKS network and S-LK wiring can be in the same conduit.
 - S-LK wiring (*not* LON wiring) can be in the same conduit with UI, AO, and DI Wiring.
-

Connect the S-LK to I/A Series MicroNet Sensor

1. Strip 1/4 in. (6mm) of insulation from S-LK wires.
2. Connect wires to screw terminals 1 and 2 (Figure-7). The S-LK terminals are polarity insensitive.
3. Push excess wire back through the base plate to minimize air flow restriction.

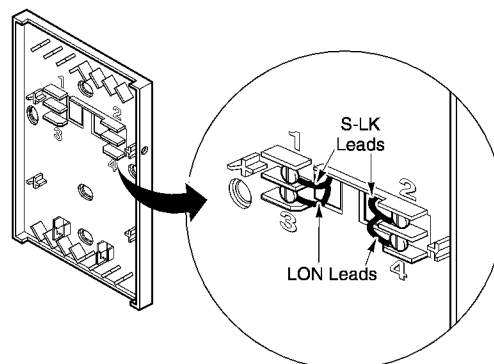

Figure-7 S-LK and LON Connections.

MicroNet LONWORKS Network (LON) Wiring

An approved two-pair cable may be used for both S-LK and optional LON connection between the controller and MN-SX sensor. LON wiring is polarity insensitive.

Caution: Do not mix with UI, DI, AO, DO, or power types of wiring.

I/A Series MicroNet Sensors use LONWORKS Free Topology Transceiver (FTT-10) and support polarity insensitive bus (daisy-chain) and free (all combinations of star, tee, and loop) wiring topologies. Four wires (a daisy chain connection) must be used to connect an I/A Series MicroNet Sensor to a doubly-terminated bus. Use two wires to connect sensors to MicroNet LonWorks network (LON). Free topology rules apply.

See *I/A Series MicroNet System Engineering Guide*, F-26507 to design a MicroNet LONWORKS FTT-10 network, including recommended topologies and approved cable types.

Connecting the LONWORKS network to an I/A Series MicroNet Sensor provides local access to the network (LON) via the sensor's LON jack. The connection is optional.

Connect LON to I/A Series MicroNet Sensor

1. Strip 1/4 in. (6mm) of insulation from LON wires.
2. Connect wires to screw terminals 3 and 4 (Figure-7). The LON terminals are polarity insensitive.
3. Push excess wire back through the baseplate to minimize air flow restriction.

Wiring Checkout

Verify wiring between I/A Series MicroNet Sensor base plate and the I/A Series MicroNet Controller is installed according to job wiring diagram, national and local wiring codes.

Electronic Assembly and Cover Installation

1. Set electronic assembly onto bottom hooks of base plate.
2. Secure electronic assembly to base plate by tightening two screws at top of assembly (Figure-8).

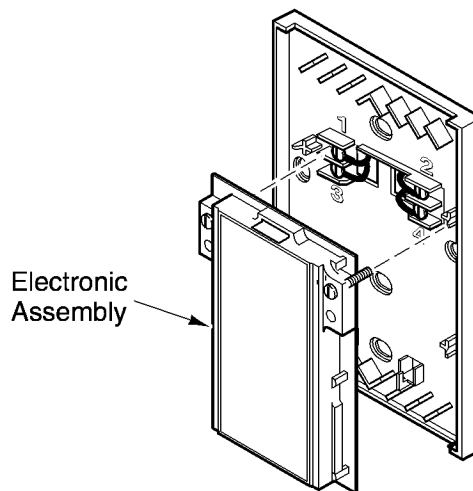

Figure-8 Electronic Assembly Installation.

3. Insert bottom tabs of cover and then snap top into place.

Note: To remove sensor cover, place thumb in middle of sensor, grasp top edge of cover with fingers and pull firmly.

Features

I/A Series MicroNet Sensor Model	Description	Features								
		Zone Temp Sensing	Override Key and LED	Setpoint Adjustment	Fan Operation and Speed	Mode (Heat/Cool Auto/Off)	Emergency Heat Key and LED	LON Jack	Display Screen	
MN-S1	The MN-S1 has no display or keypad. Its primary function is to provide zone temperature to the controller via the S-LK. Provides a LON Jack for commissioning, testing, and monitoring.	X							X	
MN-S2	The MN-S2 provides zone temperature to the controller via the S-LK and features an Override Key, with LED indicator, which forces the controller into timed occupied mode. Provides a LON Jack for commissioning, testing, and monitoring.	X	X						X	
MN-S3	The MN-S3 provides the same functionality and features as the MN-S2. In addition, the MN-S3 has a digital liquid crystal display and allows controller setpoint adjustment. The MN-S3 offers one setpoint and one default display screen.	X	X	X					X	X
MN-S4	The MN-S4 provides the same functionality and features as the MN-S3. In addition, the MN-S4 has a six-button keypad which includes a Fan Key, an Override Key, a Mode Key, and Setpoint Keys. This model allows you to select controller modes and activate fan operation and speed. The MN-S4 offers four setpoints and four display screens.	X	X	X	X	X			X	X
MN-S4-FCS	The MN-S4-FCS has a digital liquid crystal display and allows controller setpoint adjustment. In addition, the MN-S4-FCS keypad includes a Fan Key for On/Off/Auto settings and three Fan Speed keys for Low, Medium, High adjustment.	X		X	X				X	X
MN-S5	The MN-S5 provides the same functionality and features as the MN-S4. In addition, the MN-S5 features an Emergency Heat Key and LED for use in heat pump applications. The MN-S5 offers four setpoints and four display screens.	X	X	X	X	X	X	X	X	X

MicroNet LonWorks Network (LON) Jack

A LON Jack is located on the left side of each sensor model. The mating plug for the LON Jack is a 1.3mm DC power plug. Figure-9 shows location of the LON Jack.

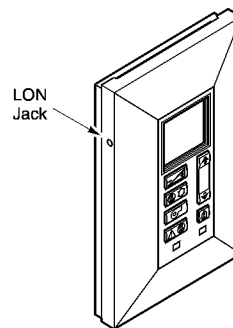

Figure-9 Location of the LON Jack.

Sensor Operation

Diagnostics

Note: The following applies to an MN-S4, MN-S4-FCS, or MN-S5 sensor connected to MN 50, MN 100, MN 150, MN 200, and VAV controllers.

In the Diagnostics Mode, the sensor times out and returns to the default screen if left idle for thirty seconds. Subnet Address, Node Address, Alarms, and Errors are view only frames. Values displayed in the Temperature Offset and Relative Humidity Offset frames are adjustable.

The I/A Series MicroNet MN-S4, MN-S4-FCS, and MN-S5 Sensors provide the following types of diagnostic data.

- Subnet Address
- Node Address
- Errors
- Alarms
- Temperature Offset
- Relative Humidity Offset

To access view only diagnostics:

View the Subnet Address, Node Address, Errors, and Alarms in this mode.

1. Press and hold both ends of Up/Down Key for four seconds. The Subnet Address frame appears.
2. Press Up/Down Key to scroll through Node Address frame, Errors frame, and Alarms frame.

To access adjustable diagnostic data:

Access Temperature Offset frame and Relative Humidity Offset frame in this mode. Skip step (1.) if you are already in the Diagnostics Mode.

1. Press and hold Up/Down Key for four seconds. The Subnet Address frame appears.
2. Press Override Key. (Press On/Off/Auto key on MN-S4-FCS.) The Temperature Offset frame appears.
3. Use Up/Down Key to adjust value.
4. To access Relative Humidity Offset frame, press Override Key (On/Off/Auto key on MN-S4-FCS) again and use Up/Down Key to adjust value.
5. To return to the Subnet Address frame, Node Address frame, Errors frame, and Alarms frame, press Override Key (On/Off/Auto key on MN-S4-FCS).

Subnet Address and Node Address : Subnet Address frames and Node Address frames display subnet and node addresses of the connected I/A Series MicroNet Controller. The LCD alternates between Subnet Address frame, numerical value of subnet address, Node Address frame, and numerical value of node address. The values displayed reflect the subnet/node address assigned to domain table index 0.

Errors: The Error frames display a value of 1, 2, 4, 8, 16, 32, or a combination of any of these values. The value may indicate one or more errors as described in Table-1. For example, an Error frame display value of 17 indicates two errors (1 = EEPROM write or read error and 16 = Analog output writing error) since $1 + 16 = 17$. The LCD alternates between the Error frame and the numerical error value. An error screen displaying dashes (--) indicates no errors.

Table-1 Error Code Descriptions.

Error Code	Controller						
	MNL-5RXX	MNL-10RXX	MNL-15RXX	MNL-20RXX	MNL-V1RVX	MNL-V2RVX	MNL-V3RVX
1	EEPROM write or read error						
2	Out of range universal input (UI1)						
4	Out of range universal input (UI2)				High velocity pressure		
8	Out of range universal input (UI3)				Low velocity pressure		
16	Analog output writing error				Analog output writing error		
32	Calibration data checksum error or unit is uncalibrated						

Alarms: The Alarm frames display the last four alarms of the connected I/A Series MicroNet Controller. The LCD alternates between Alarm frame and numerical alarm value. If the controller is sending more than one alarm, the numerical alarm value will update every four to five seconds. Alarms are defined by controller application. For information regarding specific alarm definitions, consult appropriate application documentation.

Temperature Offset: The Temperature Offset frame displays the connected I/A Series MicroNet Controller's offset value. Adjust value using the Up/Down Key.

Display Screen Functions

The MN-S3 and MN-S4-FCS models has one display screen slot. The MN-S4 and MN-S5 models have four display screen slots. The connected controller's application defines what is visible in each slot. The first display screen slot always shows the sensor's default display.

To scroll through display screens (MN-S4 and MN-S5):

1. Press either end of Up/Down Key to change from first display screen slot to second display screen slot. Before the second display screen slot appears, "-2-" will appear to indicate you are about to view the second slot.
2. Press either end of Up/Down Key to scroll through the four slots. Before the third display screen slot appears, "-3-" will appear to indicate you are about to view the third slot. Before the fourth display screen slot appears, "-4-" will appear to indicate you are about to view the fourth slot.

Emergency Heat Functions

The Emergency Heat Key activates emergency heat in heat pump applications equipped with this feature. To activate, press Emergency Heat Key. The LED indicator is lit when Emergency Heat is activated. (Does not apply to MN-S4 or MN-S4-FCS.)

Fan Functions

To display and adjust the fan (MN-S4, and S5):

1. Press the Fan Key to change from the current display to first fan slot. The sensor displays the first fan, corresponding speed icon (Table-2). and "-1-".

Note:

- There are two fan slots. The fan assigned to each slot depends on the controller application and sensor configuration.
- If the sensor displays three dashes when pressing the Fan Key, all fan slots are unassigned or not active.

2. Continue to press Fan Key to scroll through fan slots. Before the second fan appears, "-2-" will appear to indicate you are about to view the second fan.
3. Press Up/Down Key as necessary to change fan setting.
4. To enter new selection, press any key besides the Up/Down Key or wait for 15 seconds.

To activate fan speed (MN -S4, and -S5):

If the controller is equipped for multiple fan speeds, the Up/Down Key activates one of three selected fan speeds. Multiple speed fans are indicated by wavy lines next to fan icon in LCD (To see fan speed icons, refer to Table-2).

To display and adjust the fan (MN-S4-FCS):

1. Press the On/Off/Auto Key to select On, Off, or Automatic fan control. (Auto is optional and must be activated using WP Tech.)
2. Press the low, medium, or high key to adjust fan speed. (Speed indicated by 1, 2, or 3 wavy lines on key.)

General Functions

Sensor time-out

The I/A Series MicroNet Sensor times out and returns to the default display if left idle for 30 seconds. If sensor is in diagnostics mode, then time out is 30 seconds.

To enter a selection:

Press any key besides the Up/Down Key after making your selection. The selection will be automatically entered after a 15 second time-out.

To fast scroll toggle for increasing or decreasing values:

Press and hold either end of the Up/Down Key and tap and release Override Key. To terminate fast scroll, release Up/Down Key.

Mode Functions

To display and adjust modes (MN-S4 & MN-S5):

1. Press Mode Key to change from current display to first mode slot. The sensor displays the first mode, corresponding icon (Table-2). and "-1-".

Note:

- There are two mode slots. The mode assigned to each slot depends on the controller application and sensor configuration.
 - If the sensor displays three dashes when you press the Mode Key, all mode slots are unassigned or not active.
-

2. Continue to press Mode Key to scroll through mode slots. Before the second mode appears, "-2-" will appear to indicate you are about to view the second mode.
3. Press Up/Down Key as necessary to change mode.
4. To enter new mode selection, press any key besides the Up/Down Key or wait for 15 seconds.

Override Functions

The Override Key allows override of unoccupied mode setting within the controller.

- The override LED indicator is lit if the MicroNet controller is overridden to the occupied mode from the unoccupied mode.
- The override LED indicator flashes when timed override has less than 5 minutes remaining.
- If the override time is left to expire, the controller returns to the unoccupied mode.

To override the unoccupied mode:

Press (for not more than four seconds) and release Override Key. The controller goes into the occupied mode for override time specified by controller.

To Re-initialize override time:

If override time has not expired, press (for not more than four seconds) and release Override key. Override time resets to override time specified by controller.

To cancel override:

Press and hold Override Key for four seconds. Override is cancelled and controller returns to unoccupied mode.

Service Pin

To command controller to send controller service pin to the LON:

Press and hold Override key (On/Off/Auto Key on MN-S4-FCS) for eight seconds. The service pin of connected controller is sent out on the LON.

Setpoint Functions

To display and adjust setpoints (MN-S3, -S4, -S4-FCS, and -S5):

1. Press Setpoint Key to change from current display value to first setpoint slot. (Press Up/Down key on MN-S3 and MN-S4-FCS. Key must be released and pressed again to change setpoint.) The sensor displays first setpoint and corresponding icon (heat, cool, unoccupied heat, or unoccupied cool). MN-S3 will not display icon.













Note:

- The MN-S3 and MN-S4-FCS models have one setpoint slot, and the MN-S4 and MN-S5 models have four setpoint slots. The setpoint assigned to each slot depends on controller application and sensor's configuration.
- If sensor displays three dashes when you press the Setpoint Key, all setpoints slots are unassigned or not active.

-
2. Continue to press Setpoint Key to scroll through the setpoint slots. Before the next setpoint appears, "-2-" will appear to indicate you are about to view the second setpoint. ("-3-" indicates the third setpoint, -4- indicates the fourth setpoint)
 3. Press Up/Down Key as necessary to adjust any setpoint. (On MN-S3 and MN-S4-FCS, Key must be released and pressed again to change setpoint.)
 4. To enter new setpoint, press any key besides Up/Down Key or wait 15 seconds. (On MN-S4-FCS do not press any keys. Simply wait 5 seconds and the setpoint will be entered.)

LCD Icon Descriptions

Table-2 I/A Series MicroNet Sensor LCD Icon Descriptions^a

Icon	Name	Description	Icon	Name	Description
°F	Degrees Fahrenheit	Units are displayed in °F.		Heat	The Heat Icon indicates that the controller is in heat mode, or the heating setpoint is being displayed.
°C	Degrees Celsius	Units are displayed in °C.		Cool	The Cool Icon indicates that the controller is in cool mode, or the cooling setpoint is being displayed.
% 	Relative Humidity	Units are displayed in % of relative humidity.		Fan	The Fan Icon, along with the appropriate Fan Speed Icon, indicates that the fan is on.
	Outdoor Air	The Outdoor Air Icon indicates that outdoor air temperature is displayed.		Fan Speed (1-Speed Fan)	The Fan Speed Icons indicate the speed of the fan. If the fan has one speed, the appearance of three wavy lines indicates that the fan is on.
	Unoccupied	The Unoccupied Icon indicates that the unoccupied mode is active, or unoccupied setpoints are displayed. This icon is not displayed in the occupied mode.		Fan Speed (2-Speed Fan)	The Fan Speed Icons indicate the speed of the fan. If the fan has a two speed selection, the appearance of three wavy lines indicates high speed. The bottom wavy line indicates low speed.
AUTO	Auto	The Auto Icon indicates that the controller is in the auto mode.		Fan Speed (3-Speed Fan)	The Fan Speed Icons indicate the speed of the fan. If the fan has a three speed selection, the appearance of three wavy lines indicates high speed. The middle and lower wavy lines indicates medium speed, and the bottom wavy line indicates low speed.
	Off	The Off Icon indicates OFF for a mode or fan selection.		Fan Speed (3-Speed Fan)	The Fan Speed Icons indicate the speed of the fan. If the fan has a three speed selection, the appearance of three wavy lines indicates high speed. The middle and lower wavy lines indicates medium speed, and the bottom wavy line indicates low speed.
	On	The On Icon indicates ON. For example, the On Icon may indicate that a connected device is operating manually or that room lights are on. The On Icon may represent auxiliary heat during normal heat pump operation or a possible selection in the fan selection list.		Fan Speed (3-Speed Fan)	The Fan Speed Icons indicate the speed of the fan. If the fan has a three speed selection, the appearance of three wavy lines indicates high speed. The middle and lower wavy lines indicates medium speed, and the bottom wavy line indicates low speed.

^aLCD icons and icon definition vary depending on connected I/A Series MicroNet Controller and its application. Refer to application documentation for more information.

Service

Table-3 Troubleshooting.

Sensor Condition	Corrective Action
LCD remains blank.	<p>Check sensor and controller wiring and correct, if necessary. If wiring is okay, check to see if power is being applied to the sensor by pushing the Override Key for less than four seconds. If the Override LED lights up, the sensor is powered. If the Override LED does not light up, the sensor may not be receiving power. Check controller power to verify presence. If the above measures do not address the problem, download a new application to the controller.</p>
Sensor displays "Abn" indefinitely.	<p>Check the documentation to make sure the sensor model is compatible with the controller application and then choose one of the following options. If the sensor and application are compatible, download a new application to the controller. If the sensor and application are incompatible, download an application that is compatible with the sensor. Or, install a sensor that is compatible with the controller application.</p>
All LCD icons light up and remain lit.	<p>Check to see if the controller is constantly resetting and correct, if necessary. Check sensor and controller wiring and correct, if necessary. If reset and wiring are okay, download a new application to the controller. If the above measures do not address the problem, the controller may need to be configured. For configuration instructions, consult documentation associated with the network management tool.</p>

Components within I/A Series MicroNet Sensors can not be field repaired. If there is a problem with a sensor, follow the steps below before contacting your local Siebe Environmental Controls office.

1. Make sure sensors are connected and communicating to desired devices.
2. Record precise hardware setup indicating the following:
 - Version numbers of applications software.
 - Controller firmware version number.
 - Information regarding the WorkPlace Tech Tool.
 - A complete description of difficulties encountered.

I/A Series is a registered trademark of an Invensys company.
LON, LONWORKS, and LONMARK are registered trademarks of
Echelon Corporation.

