

# Powers™ Controls

## D Room Thermostat Direct Acting

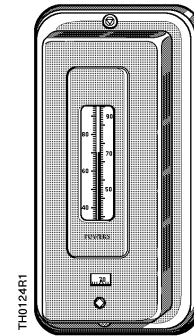

### Description

Powers D Room Thermostat is a gradual-acting, pneumatic instrument recommended for room temperature control in heating and air conditioning applications. Among the outstanding features of the D thermostat are its rapid response to temperature change and its unique design which prevents a constant waste of air. Other features include a wide range of adjustment, noncorrosive parts, ease of calibration and quiet operation. These factors ensure long, dependable life and maintenance-free operation.

The thermostat cover and base are designed to blend with all color schemes and furnishings. The standard instrument has a calibrated thermometer and either exposed or concealed adjustment. Factory replacement parts and instructions for servicing are available, should they be required.

### Application

While the D Room Thermostat is primarily designed for control of individual rooms heated or cooled by radiation, ventilation or an air conditioning system, it is very versatile. Other applications include room control of radiant panels, finned radiation and unit ventilators.

### Product Numbers

Table 1.

Product Numbers	Description
832-0120	Concealed adjustment with thermometer
832-0490	Concealed adjustment without thermometer
832-0500	Exposed key adjustment with thermometer
832-1260	Exposed knob adjustment with thermometer

### Typical Specifications

All thermostats are equipped with a vapor pressure operated sensing element, shall be capable of responding to a change of plus or minus 1/2°F (0.3°C), and shall be gradual acting capable of positioning valves or dampers in intermediate positions. The thermostats shall be of the non-bleed type so that no air shall be used except when positioning a valve or damper motor. The thermostats shall be provided with an adjustable range of 60°F to 85°F (15°C to 30°C).

---

## Specifications

<b>Operating</b>	Range	60°F to 85°F (15°C to 30°C)
	Sensitivity	2-1/4 psi/°F (27.0 kPa/°C)
	Normal supply pressure	18 psi (124 kPa)
	Maximum supply pressure	30 psi (206 kPa)
	Maximum ambient temperature	110°F (43°C)
	Temperature response	1/2°F (0.3°C)
	Weight	3 lbs (1.4 kg)
	Dimensions	See Figure 6

---

## Operation

A direct acting thermostat will increase control pressure with a rise in temperature and decrease control pressure with a drop in temperature. The thermostat may be controlling a mixing damper supplying hot or cold air to a room. The exhaust valve chamber is connected by a branch line directly to the damper motor controlling the position of the hot and cold blades. See Figure 1.

When room temperature increases, the thermostat increases the control pressure to the motor to close the hot blade and open the cold blade. Conversely, with a drop in room temperature, the thermostat reduces the control pressure to close the cold blade and open the hot blade. Due to the gradual action of the Powers Type D Thermostat, the hot and cold blades may be positioned in an intermediate position to satisfy the room's needs.

The Type D Thermostat is a force-balance type of instrument. When temperature rises, the vapor pressure within the thermostatic discs increases and overcomes the pressure exerted by the air in the exhaust valve chamber. The first action is to seat the exhaust valve. Then the supply valve is moved from its seat and allows air to flow into the return line. This unique feature prevents the constant waste of air. The air pressure in the exhaust valve chamber exerts a feedback pressure in opposition to the vapor pressure in the disc. Therefore, whenever there is sufficient air pressure to balance the vapor pressure of the discs, the supply valve returns to its seat and no more air is permitted to pass through.

Upon a drop in temperature, the vapor pressure within the thermostatic discs decreases and the greater air pressure in the exhaust valve chamber results in a reverse movement of the exhaust valve assembly. This allows the supply valve to close and the exhaust valve to open gradually to reduce the control pressure. The force in the exhaust valve chamber always tends to balance the force of the thermostatic discs to maintain desired room conditions.

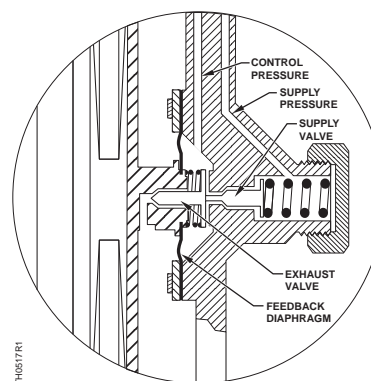

**Figure 1. Supply Exhaust Valve.**

**Calibration**

1. Check room temperature. It should be approximately 70°F to 75°F (21°C to 24°C).
2. Remove thermostat cover using adjustment key (Part No. 856-055). See Figure 2.

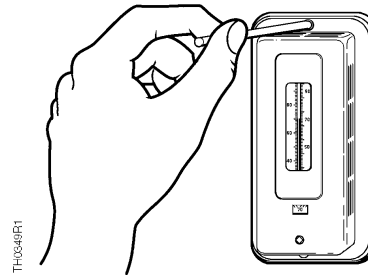
**Figure 2. Removing the Thermostat Cover.**

3. Loosen test screw (see Figure 3) 1/2 turn counterclockwise then attach test gauge and hose assembly over the test screw body.

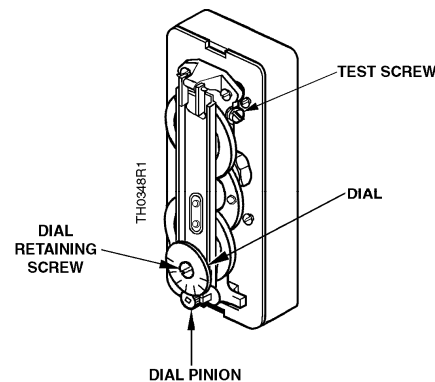
**Figure 3.**

4. Stand away from thermostat for about five minutes. If control pressure does not read 7 to 8 psi (48 to 55 kPa), turn adjustment screw with key (Part Number 856-055) until this pressure is obtained.
5. If the dial reading and room temperature do not agree, loosen dial retaining screw. (See Figure 3.)
6. Tilt and rotate until dial reading agrees with room temperature. Do not turn dial pinion. Retighten dial retaining screw.

The instrument is now in calibration and can be set to desired room temperature.

## Construction

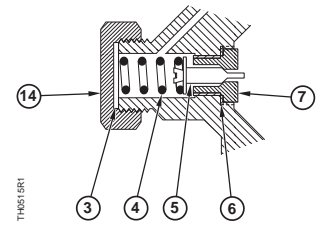
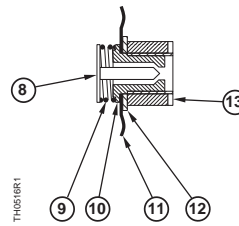
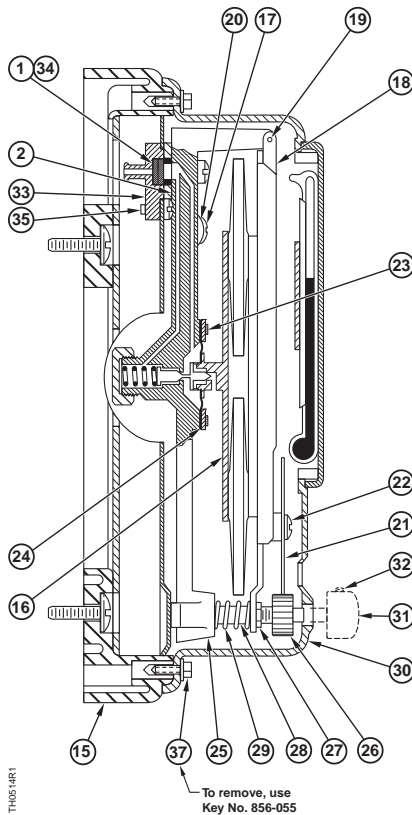

Figure 4. Supply Valve.

Figure 5. Exhaust Valve.

Table 2. Parts List.

Item No.	Description	Part Number	
1.	Screen Filter	Kit Number 832-164	
2.	Terminal Gasket		
3.	Supply Valve Cap Gasket		
4.	Supply Valve Spring		
5.	Supply Valve Stem		
6.	Supply Valve Gasket		
7.	Supply Valve Body		
8.	Exhaust Valve Stem		
9.	Exhaust Valve Spring		
10.	Exhaust Valve Body		
11.	Exhaust Valve Diaphragm		
12.	Exhaust Valve Diaphragm Plate		
*13.	Exhaust Valve Nut		
*13.	Exhaust Valve Nut (For 832-1260)		830-015
14.	Supply Valve Cap		833-013
15.	Base Plate Assembly		181-091
16.	Motor Disc Assembly		934-007
17.	Test Plug	833-009	

\*Order extra 830-015C in excess of 832-164 kit for repair of 832-1260 thermostat.

Item	Description	Part
18.	Lever Assembly	—
19.	Self-locking Pivot Pin	—
20.	Test Valve Body	833-008
21.	Dial	833-010
22.	Dial Screw	181-021
23.	Screw	—
24.	Diaphragm Ring	934-011
25.	Frame	—
26.	Dial Pinion	181-064
27.	Lever Nut	833-067
28.	Adjustment Screw (For 832-1260)	833-075
28.	Adjustment Screw (For all others)	833-017B
29.	Return Spring	221-054
30.	Cover	See Table 3
31.	Knob (Friction)	833-033
31.	Adjustment Knob (For 832)	833-080
32.	Set Screw (For 832-1260 Only)	034-351
33.	Terminal Head	832-159
34.	Filter Disc	—
35.	Screw	030-042
36.	Adjustment Key (Not Shown)	856-055
37.	Screw	856-014

Table 3. (Replacement Covers)

30.	For Thermostat Number	Cover
	832-0120	856-036
	832-0490	856-046**
	832-1260	856-044
	832-0500	856-044

\*\*Two 856-014 screws required with this cover.

Replacement Kit No. 832-040 consists of D thermostat, less cover and base.

**Service Kits**

**Table 4.**

Product Number	Description
832-040	D thermostat chassis without cover and base
See Table 3	Replacement covers
832-164	Exhaust Supply Valve Repair Kit
832-034	Base Kit for mounting D thermostat with exposed tubing

**Dimensions**

**TH 832 "D" ROOM THERMOSTAT**

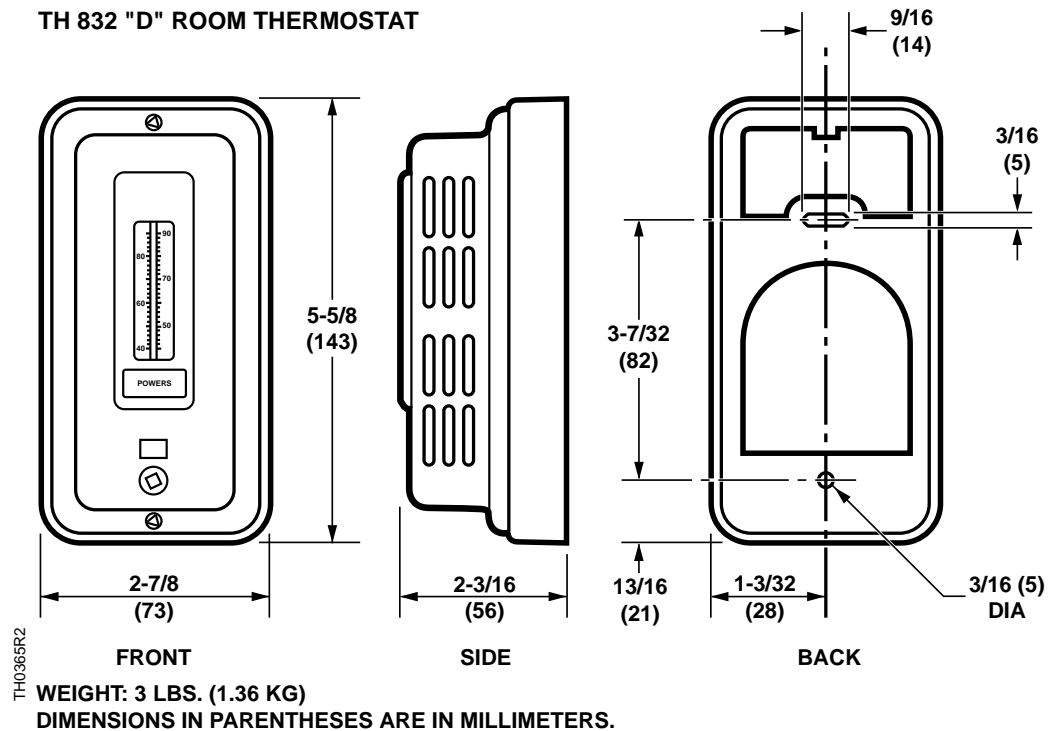

**Figure 6. Dimensions in Inches (Millimeters in Parentheses).**

Information in this publication is based on current specifications. The company reserves the right to make changes in specifications and models as design improvements are introduced. Powers is a registered trademark of Siemens Industry, Inc. Product or company names mentioned herein may be the trademarks of their respective owners. © 2009 Siemens Industry, Inc.