

# SIEMENS

## Powers™ Controls

### TH 192 S Single Temperature Room Thermostat

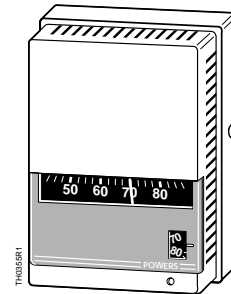

#### Description

The TH 192 S thermostats are proportional single output, single set point, 1-pipe (low air capacity) or 2-pipe (high air capacity) sensor controllers. Each thermostat includes a wall mounting plate for installation in a variety of rough-in terminal boxes. A sensitive bimetal responds to temperature change to modulate control air through a flapper nozzle. One set point dial is provided. Air connections are made with 5/32" (4 mm) OD plastic tubing, directly to the thermostat chassis for retrofit applications or with plug-in adapters (provided with the TH 192 rough-in terminal box or optional accessories) which slide into the wall mounting plate.

#### Features

- Direct and reverse acting models for one and two-pipe
- Fahrenheit or Celsius set point dials
- Highly sensitive bimetal thermostatic element
- Field adjustable sensitivity with graduated scale
- Integral field adjustable limit stops
- Control pressure test port accessible without removing cover
- Easily replaceable thermometer, set point dial, filters, and restrictor plate
- Covers available for concealed or exposed thermometers and for either concealed, key, or exposed knob adjustment and set point indication
- Standard plastic thermostat covers provide desert beige or white finish

#### Optional Design Features

- Fixed temperature limit stops meet government specifications
- Competitor adapter mounting kits available
- Metal covers available in standard configurations with a variety of finishes
- All thermostat chassis available with optional 1/2" large set point adjustment knobs

## Application

TH 192 S thermostats are temperature sensing devices that control pneumatic valve and damper actuators in heating and cooling applications such as air conditioners, space heaters, unit ventilators, and air volume controllers. The thermostats maintain energy management (maximum economy) and occupant comfort. TH 192 S thermostats are available with covers that conceal or expose the set point adjustment dial.

Use TH 192 S 1-pipe thermostats with an external restrictor (20 scim, 5.4 ml/sec) where a limited air capacity operates a single valve and/or actuator. Use TH 192 S 2-pipe thermostats where multiple valves and actuators, used with or without high/low limiting controls, require higher air capacities.

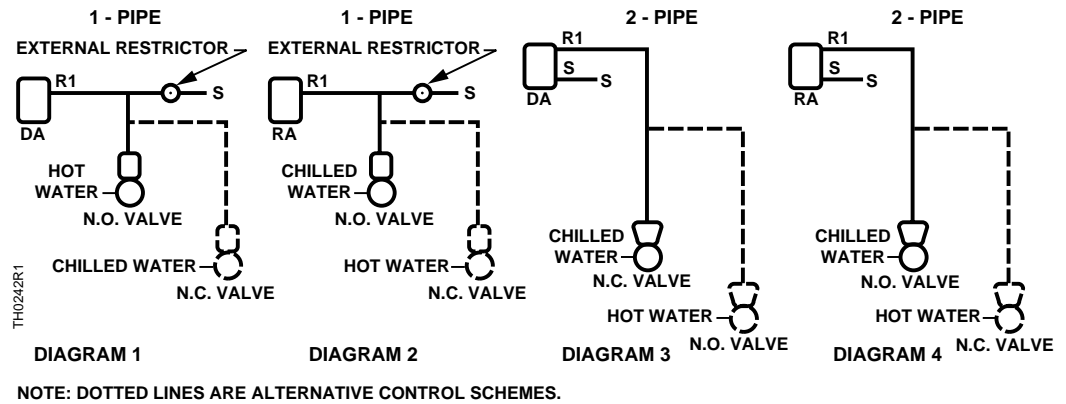

Figure 1. Typical TH 192 S Thermostat Applications.

## Piping

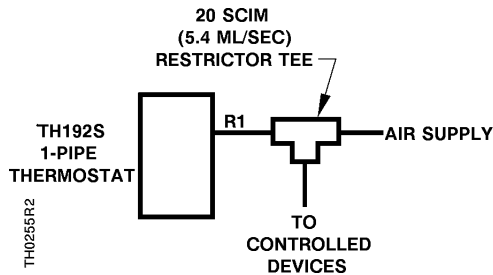

Figure 2. TH 192 S One-Pipe Thermostat Connections.

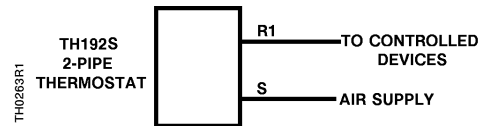

Figure 3. TH 192 S Two-Pipe Thermostat Connections.

## Product Numbers and Ordering Information

### Chassis

See Table 1 for product number and ordering information on TH 192 S thermostat chassis.

1. Is a one-pipe (low air capacity) or two-pipe (high air capacity) connection required for application?
2. Is a Fahrenheit or Celsius scale required?
3. Is the control action direct or reverse acting?
  - a. Direct acting: An increase in temperature increases the control air pressure.
  - b. Reverse acting: An increase in temperature decreases the control air pressure.
4. Where is set point adjustment knob located?
  - a. Adjustment knob located at bottom of chassis.
  - b. Adjustment knob on front with 1/2" large exposed knob.

**Table 1. TH 192 S Thermostat Chassis Part Numbers.**

Chassis with Wall Plate					
Set Point Adjustment	Connection Type	Fahrenheit		Celsius	
		Direct Acting	Reverse Action	Direct Acting	Reverse Acting
Exposed at Bottom of Cover	Two-pipe, relay	192-202	192-203	192-222	192-223
	One-pipe, non-relay	192-200	192-201	192-220	192-221
Exposed 1/2" Knob on Cover *	Two-pipe, relay	192-202K	192-203K	192-222K	192-223K
	One-pipe, non-relay	192-200K	192-201K	192-220K	192-221K

\* This feature requires a key set point adjustment cover (or key type cover). See Table 2.

Covers

See Table 2 for product number and ordering information on TH 192 S thermostat covers.

1. Is the set point adjustment exposed for customer adjustment or concealed to prevent alteration of setting?
2. Is the thermometer exposed or concealed?
3. Is the set point indication exposed or concealed behind cover?
4. Is a plastic or zinc cast metal cover required?
  - a. Plastic covers order 192-2XX.
  - b. Metal covers order 192-3XX.
5. Is finish of cover standard or optional?
  - a. Standard cover is plastic, desert beige color.  
 For white plastic cover option, add "W" suffix code to cover part number (e.g., 192-256W).
  - b. Optional covers are plastic or metal and available in a variety of colors per Table 3.

**Table 2. TH 192 S Thermostat Cover Part Numbers.**

Set Point Adjustment	Cover Configuration		Cover Part Number (See Note 2)	
	Thermometer	Set Point Indicator	Standard Plastic Cover	Standard Metal Cover
Concealed	Concealed	Concealed	192-256	192-356
	Exposed		192-254	192-354
Key (See Note 1)	Concealed	Exposed	192-265	192-365
	Exposed		192-266	192-366
Exposed	Concealed	Exposed	192-250	192-350
	Exposed		192-252	192-352

1. Key set point adjustment cover required for all thermostat chassis with optional 1/2" large set point adjustment knobs.
2. To order an optional thermostat cover finish, add the appropriate suffix letter listed in Table 3 to the end of the part number listed in Table 2.

**Table 3. TH 192 S Thermostat  
Suffix Letters for Optional Cover Part Numbers.**

**NOTE:** For color samples, order color reference guide 152-178P10.

Part Number Suffix Letter	Cover Material	Cover Finish	Part Number Suffix Letter	Cover Material	Cover Finish
None	Plastic (standard)	Desert Beige	D	Metal (optional)	#10 Special Bronze
W	Plastic (optional)	White	E		Brushed Electro-plated Satin Chrome
None	Metal (standard)	Desert Beige	F		Sierra Gold
A	Metal (optional)	#1 Silver	G		Brushed Aluminum
B		#5 Satin Chrome	H		White
C		#7 Light Statuary Bronze			

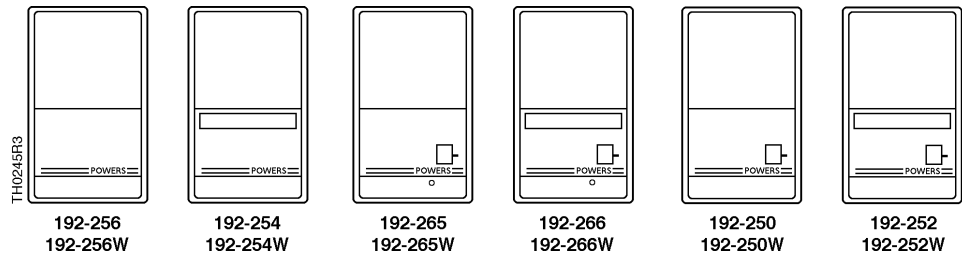

**Specifications**

Control action	See Table 1.
Operating range	45 to 85°F (7 to 30°C)
Supply air pressure, maximum	30 psi (207 kPa)
Normal air supply pressure	18 to 25 psi (124 to 172 kPa)
Sensitivity adjustment	1 to 4 psi/°F (12 to 50 kPa/°C)
Nominal air consumption	
One pipe	25 scim (6.8 ml/sec)
Two pipe	20 scim (5.5 ml/sec)
Temperature	
Storage temperature	-10 to 140°F (-23 to 60°C)
Ambient operating temperature	40 to 140°F (4 to 60°C)
Temperature response	0.1°F (0.06°C)
Dial graduations	2°F (1°C)

**Specifications**

(Continued)

Factory settings	
Calibration @ 72°F (22°C)	7.5 psi (52 kPa)
Sensitivity	2.5 psi/°F (31 kPa/°C)
Limit stop adjustment	45 and 85°F (7 and 30°C)
Standard cover	Cyclac, desert beige
Shipping weight	0.7 lbs. (0.3 kg)
Dimensions	See Figure 4.

**Accessories**

See the following Technical Bulletins for information on accessories.

Technical Bulletin	Document Number
TB 237 Terminal Kits	155-244
TB 213 Aspirator Wall Box Kit	155-245
TB 214 Adapter Kits	155-231
TB 193 Guard Kit	155-222
TB 241 Test Head Kit	155-255
TB 167 Restrictors	155-213

**Dimensions**

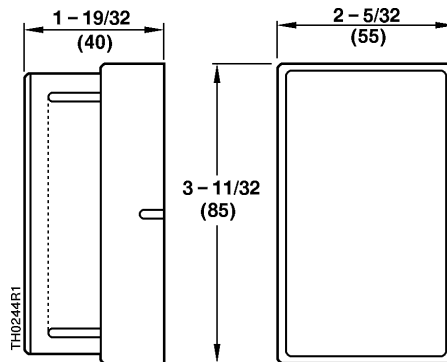
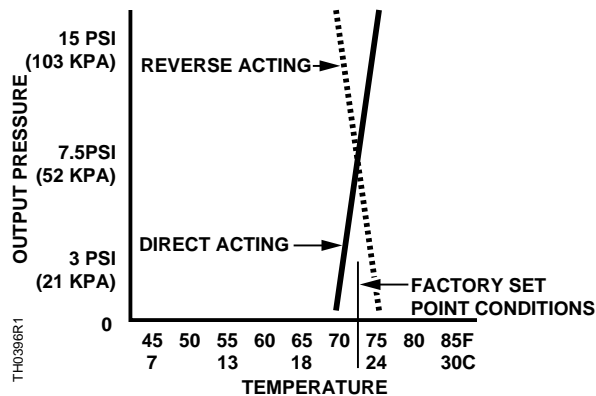

**Figure 4. TH 192 S Dimensions in Inches (Millimeters).**

**Operation**

In the TH 192 S direct acting thermostat, an increase in temperature increases the control air pressure and a decrease in temperature decreases the control pressure.

In the TH 192 S reverse acting thermostat, an increase in temperature decreases the control air pressure and a decrease in temperature increases the control pressure.



**Figure 5. TH 192 S Input/Output Characteristics.**

## TH 192 S Thermostat Details

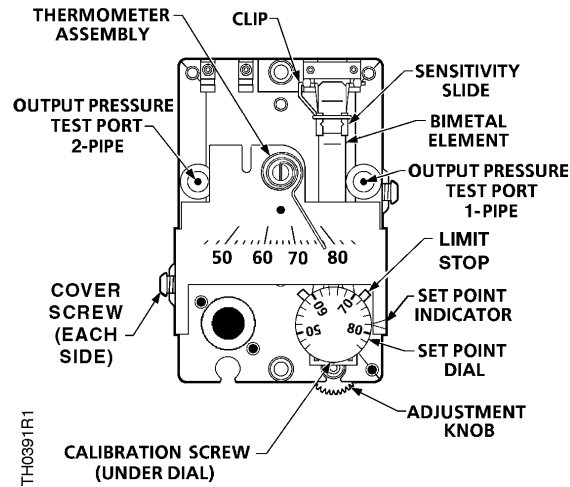

**Figure 6. TH 192 S Thermostat Details.**

### Thermometer Calibration

1. Use a test thermometer to read the current room temperature.
2. Place a screwdriver in the center of the thermometer assembly (Figure 6). Carefully rotate thermometer assembly until pointer tip indicates the correct room temperature.

**NOTE:** Avoid breathing on or touching the bimetal spiral since this affects the temperature reading.

### Limit Stop Adjustment

Thermostat limit stops define the minimum and maximum thermostat set points. The limit stops engage in the set point cam gear teeth and cause interference between the set point cam gear and the adjustment knob gear.

To change limit stop settings, use needle nose pliers to pull limit stop between the set point cam gear teeth. Rotate limit stop to its new position. Do not pull limit stop any more than necessary to clear the gear teeth. Changing the limit stop position one gear tooth changes the limit stop setting by 1-1/3°F (0.7°C).

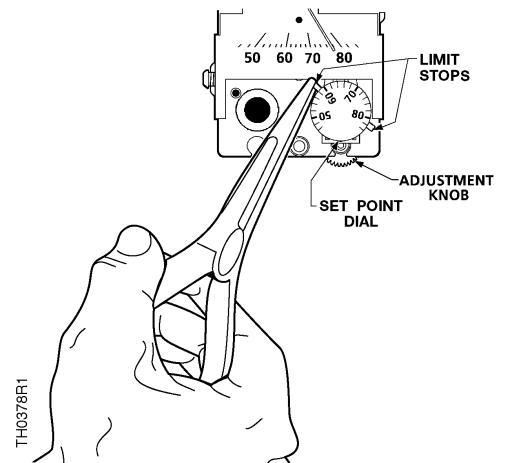

**Figure 7. TH 192 S Limit Stop Adjustments.**

## Sensitivity Adjustment

To change thermostat sensitivity, use a flat blade screwdriver to carefully move the sensitivity slide to the desired position as follows:

Graduation closest to the rigid end of the bimetal element  
4 psi/°F  
(50 kPa/°C)



Graduation closest to the minimum (MIN) end of the bimetal element  
1 psi/°F  
(12 kPa/°C)

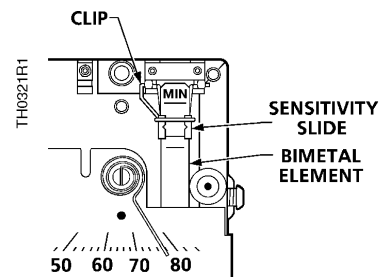
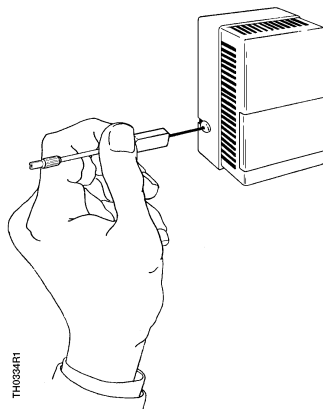

**Figure 8. TH 192 S Sensitivity Adjustment.**

**NOTE:** If the thermostat sensitivity is adjusted, the thermostat must be recalibrated.

## Thermostat Calibration

The thermostat is factory calibrated to a control pressure of 7.5 psi (52 kPa) when the set point and the ambient temperature are both at 72°F (22°C). The factory sensitivity setting is approximately 2.5 psi/°F (31 kPa/°C). No adjustments are required if these settings are appropriate for the application. If the thermostat has been tampered, the sensitivity changed, or is out of adjustment, use the following steps to re-calibrate the instrument.



**Step 1 —**  
Remove cover using 192-632 calibration tool. Verify room temperature is between 70 and 80°F (21 and 27°C).

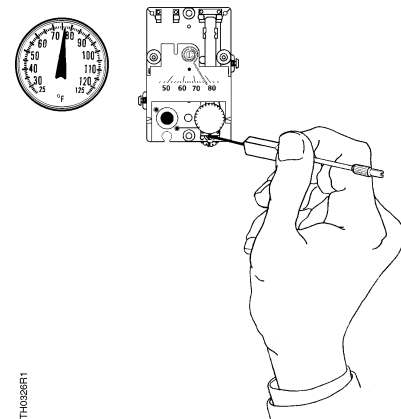

**Step 2 —**  
Verify that supply pressure is 18 psi (124 kPa). Set dial to room temperature by turning the exposed adjustment knob or using a hex key as shown. Allow thermostat to stand for about five minutes to adjust to the new setting.



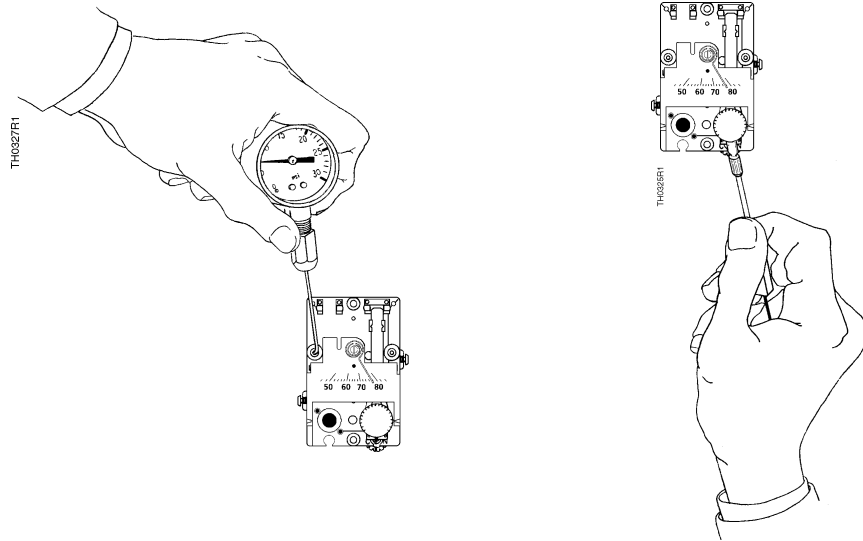

**Step 3 —**  
Moisten needle and insert 192-633 test gauge and needle adapter in a test port. Read control pressure.

**Step 4 —**  
If control pressure does not read 7 to 8 psi (48 to 55 kPa), turn calibration screw using 192-632 calibration tool or 1/8" (3.2 mm) wrench until pressure is 7 to 8 psi (48 to 55 kPa). The sensing element is now in calibration and the set point can be changed to the desired room temperature.

**Troubleshooting**

Before troubleshooting thermostat per Table 4, make certain there is clean dry supply air at 18 psi (124 kPa) minimum. Use test probe gauge and needle adapter to measure control pressure at thermostat test port.

The output pressure test port is accessible without removing the thermostat cover through the 8th opening from the top. For one-pipe thermostats, the port is on the right side. For two-pipe thermostats, the port is on the left side.

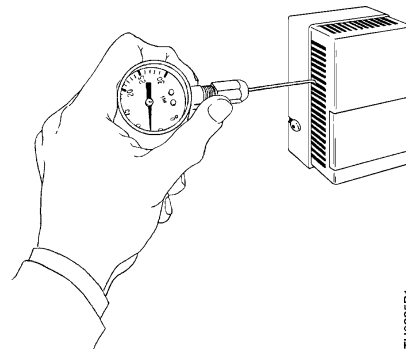

**Figure 9. Accessing Output Pressure Test Port.**

**Table 4. Troubleshooting Guide.**

Problem	Check	Cause	Action
Control pressure stays at approximately zero	Air supply	Low supply pressure	As required
	Nozzle or flapper	Dirt on nozzle or flapper	Clean nozzle or replace thermostat
	Restrictor	Clogged restrictor	Replace restrictor
	Calibration	Out of calibration	Recalibrate
Control pressure stays at approximately supply pressure	Nozzle	Clogged nozzle	Clean nozzle or replace thermostat
	Calibration	Dirt on either supply or exhaust valve seat	Alternately close and open nozzle by gently pushing down the bimetal
Excessive air leakage from exhaust port on left side of thermostat	Supply and return line connection	Connections are interchanged or connection to port is incorrect	As required

### Chassis Tube Connector and Restrictor Plate Replacement

1. Remove thermostat chassis from wall. Terminal does not have a ball check valve.

**NOTE:** You must close off the supply air. For example, use a connector with the supply air terminal plugged.

2. Remove two Phillips head screws from connector on back of thermostat chassis. Pull connector out of recess. If necessary, pry connector loose with a screw driver, but be careful not to damage restrictor plate and gasket.
3. Remove gasket from under connector. Remove restrictor. Remove second gasket from under restrictor.
4. Use restrictor replacement kit 192-321 to replace gasket, restrictor, and second gasket.

**NOTE:** The restrictor plate is keyed to ensure proper orientation during installation.

5. Remove filters from existing connector and insert in new connector. Or, if filters are dirty, use restrictor replacement kit 192-321 to replace filters.
6. Use chassis tube connector replacement kit 192-525 to replace connector and mounting screws.

**Service Parts**

The following chart lists accessory parts and tools available for thermostat service.

Description	Part Number
Dial thermometer (-40 to 140°F, -40 to 60°C) with pocket case	141-0573
Basic pneumatic calibration kit with thermometer, gauge, squeeze bulb, fittings, and case	832-177
Test head kit	832-179
Calibration tools	832-178
Test probe to check pressure with cover on	
Needle probe with 1-1/2" diameter gauge 0-30 psig (0-200 kPa) and calibration/cover wrench	192-633
Needle probe, no gauge (package of five)	192-759
1-1/2" diameter gauge, 0-200 kPa, back connected 1/8" NPT male	142-0344
1-1/2" diameter compound gauge, 0-30 psig/0-200 kPa, back connected 1/8" NPT male	142-0373
1-1/2" diameter compound gauge, 0-30 psig/0-200 kPa, bottom connected 1/8" NPT male. Replacement for use with 192-633	142-0426
Chassis tube connector replacement kit with mounting screws (material for 10 thermostats included)	192-525
Restrictor plate replacement kit with filters and gasket (material for 10 thermostats included)	192-321
Plug-in adapters for quick thermostat removal	
Straight, blue (package of 20)	192-485
Straight, white (package of 20)	192-486
Air link connects adapters for pressure tests (package of 20)	192-501
Compression ring (package of 100)	141-388
Elbow (provides quick return for wall surface mounting), blue (package of 20)	192-487
Elbow (provides quick return for wall surface mounting), white (package of 20)	192-488
20 scim (5.4 ml/sec) restrictors for 1-pipe systems (package of 5). (1/4", 6.4 mm, OD plastic barb unless noted.)	
Brass coupling, 1/8" NPT (1 only).	184-040
Coupling	184-116
Tee	184-113
Pre-piped dual tee for dual 1-pipe systems	184-130

**Service Parts**  
 (Continued)

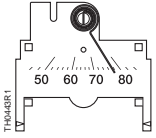
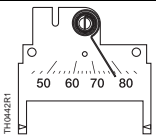
Description		Part Number	
Replacement thermometer kits, brown (packages of 5)			
Scale Range	Thermostat Model		
45° to 85°F	 Model 3 and Up	192-775	
10° to 30°C		192-776	
45° to 85°F	 Models 1 and 2	192-786	
10° to 30°C		192-785	
Replacement set point dials (packages of 10)			
°F, Direct Acting	Right Side		192-779
°F, Reverse Acting			192-780
°C, Direct Acting			192-783
°C, Reverse Acting			192-784
°F, Direct Acting	Left Side		192-777
°F, Reverse Acting			192-778
°C, Direct Acting			192-781
°C, Reverse Acting		192-782	

Information in this publication is based on current specifications. The company reserves the right to make changes in specifications and models as design improvements are introduced. © 1999 Siemens Corporation