

## Table of Contents

PRODUCT	PRODUCT CODE	TECHNICAL INSTRUCTIONS	PAGE #
<b>Pneumatic Auxiliary Equipment</b>			
Air Station Equipment	201/656/908	155-005/049/086/137P25	H-3
Pressure Gauges	GA142AP	155-025P25	H-7
External Restrictors	184	155-213P25	H-9
Pneumatic Tube Fitting Kit	141	155-108P25	H-13
<b>Controls Cabinet</b>			
Controls Cabinet	CP 567	155-272P25	H-15
<b>Accessories &amp; Service Kits</b>			H-17

**Standard Shipping within 3 to 5 days** Products ordered through the Rapid Response™ program can ship same day. Expect longer lead times for large quantities and unique parts. See inside back cover for details on Rapid Response™ shipping.

## Need additional assistance?

Contact Siemens Inside Sales or your Account Executive any time.  
Call Inside Sales at 1-888-593-7876 from 7 am to 5:30 pm (CST)  
Monday through Friday. Or, send an email to  
[bgcustomersupport.us.sbt@siemens.com](mailto:bgcustomersupport.us.sbt@siemens.com)

We appreciate your business and look forward to helping you!



## Air Station Equipment



656-0009  
High Capacity, 3-way Pilot Valve.



201-1000 Single-stage,  
Compressed Air Pressure Reducing Valve.



908-051  
Compressed Air Filter.

### Description

Providing pneumatic control, Air Station Equipment, which includes Single- and Dual-stage Pressure Reducing Valves and High Capacity, 3-way Pilot Valves, responds rapidly to large volume demands and supply pressure variations. The Compressed Air Filter removes water or oil to 0.025 particle size.

### Features

#### Pressure Reducing Valve

- 200 mesh stainless strainer
- Locking handle
- Dual tappings for right or left-hand gauge (201-1000)
- Gauge plug and bushing
- 2-1/2" (64 mm) gauge with 0 to 30 psig (0 to 207 kPa) (201-1001, 201-1002)

#### Compressed Air Filter

- 10 scfm (17 m<sup>3</sup>/hr) capacity
- Drain port
- Replaceable cartridge

### Applications

Air Station Equipment and compressor systems are available for schools, hospitals, commercial office and industrial buildings, and other facilities.

#### Compressed air systems include:

- Single (low) pressure
- Dual (low and high) pressure
- Dual, low pressure for two pressure systems

Your local Siemens Building Technologies representative can assist you in selecting the appropriate air compressors and accessories for optimum efficiency and duty cycling.

# Air Station Equipment Specifications

## Single-stage, Compressed Air Pressure Reducing Valve, 201-1000

Capacity ..... 8 scfm (17 m<sup>3</sup>/hr)  
 Maximum Inlet Pressure ..... 250 psig (1734 kPa)  
 Reducing Pressure Range ..... 0 to 50 psig (0 to 345 kPa)  
 Inlet/Outlet Connections ..... 1/4" NPT Female  
 Gauge Port ..... 1/4" NPT Male x 1/8" NPT Female bushing  
 Shipping Weight ..... 1.7 lb. (0.8 kg)

## Compressed Air Filter, 908-051

Capacity ..... 10 scfm (17 m<sup>3</sup>/hr)  
 Maximum Pressure ..... 150 psig (1034 kPa)  
 Inlet/Outlet Ports ..... 3/8" NPT Female  
 Shipping Weight ..... 2.1 lb. (0.95 kg)

## High Capacity, 3-way Pilot Valve

Application ..... Two-pressure systems/  
 Day-Night or Heat-Cool  
 Inlet/Outlet Ports ..... 1/2" (12 mm) O.D. SAE flare  
 Pilot Port ..... 1/8" NPT Female  
 Actuator ..... 3 to 8 psi, 10 to 15 psi (69 to 103 kPa)  
 Valve Specifications ..... Cv=2.5, 14 scfm (24 m<sup>3</sup>/s) based on  
 18 psig (124 kPa) with a 1 psi (7 kPa) pressure drop  
 Shipping Weight ..... 2.0 lb. (0.9 kg)

## High Capacity, 3-way Pilot Valve

Application ..... Two-pressure systems/  
 Day-Night or Heat-Cool  
 Inlet/Outlet Ports ..... 1/2" (13 mm) O.D. SAE flare  
 Pilot Port ..... 1/8" NPT Female  
 Actuator ..... 3 to 8 psi (21 to 55 kPa)  
 Valve Specifications ..... Cv=2.5, 14 scfm (24 m<sup>3</sup>/s) based on  
 18 psig (124 kPa) with a 1 psi (7 kPa) pressure drop  
 Shipping Weight ..... 2.0 lb. (0.9 kg)

H-4

Auxiliary Equipment

## Air Station Equipment Product Ordering

Description	Part No.
Single-stage, Compressed Air Pressure Reducing Valve	201-1000
Compressed Air Filter	908-051
High Capacity, 3-way Pilot Valve (10 to 15 psi)	656-0009
High Capacity, 3-way, Pilot Valve (3 to 8 psi)	656-0010

Accessories & Service Kits

H-18

# Application Drawings

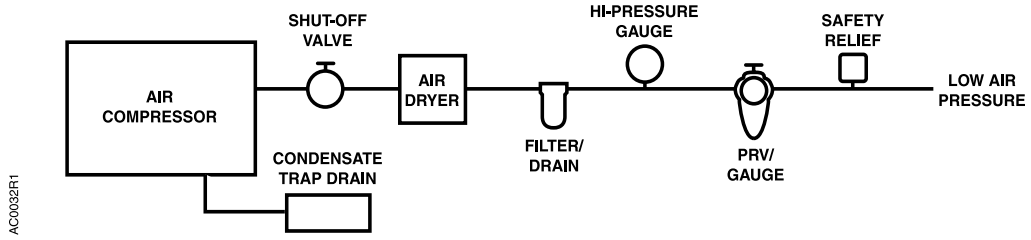

Single Pressure.

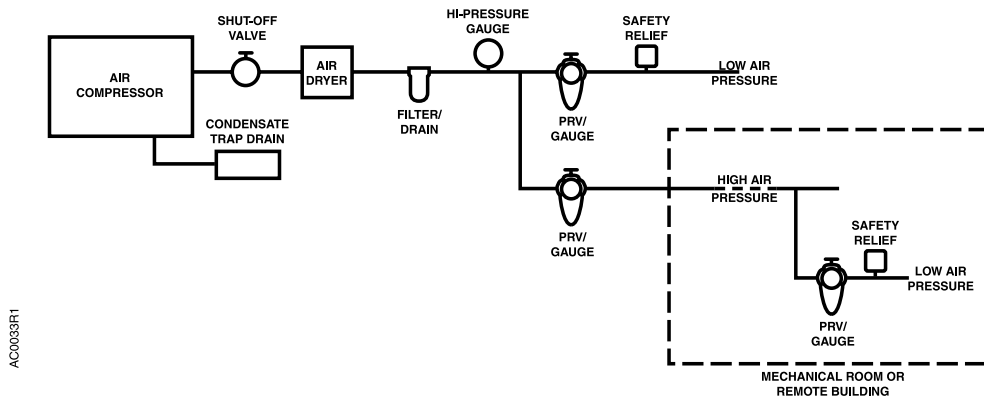

Low and High Pressure.

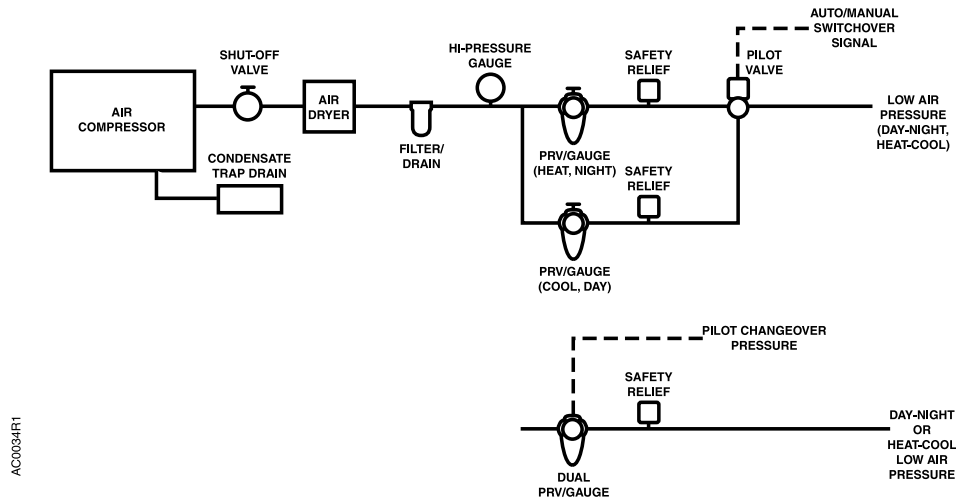

Dual Pressure.

## Online Order History

This handy online feature stores all your past and current orders online for quick and easy reference. The Order History function lets you access information such as:

- Ordered By
- Date Placed
- Order Number
- Products Ordered
- Shipping Date
- Shipment Tracking

To view your history and status, register online at  
[www.usa.siemens.com/buildingtechnologiesonlineordering](http://www.usa.siemens.com/buildingtechnologiesonlineordering)



## Pressure Gauges

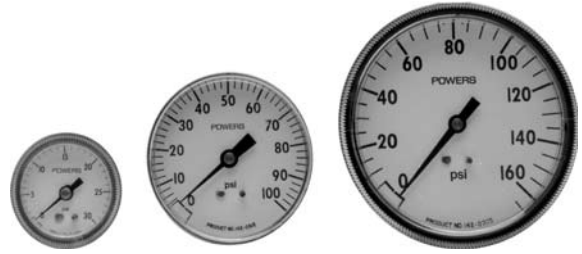

1-1/2", 2-1/2" and 3-1/2" Pressure Gauges.

### Description

Pneumatic pressure gauges are used wherever visual indication of pressure is required.

### Features

- Accuracy 2.5% of full scale for the middle half of scale; 3.5% elsewhere
- Available in 1-1/2-inch (38 mm), 2-1/2-inch (64 mm) and 3-1/2-inch (89 mm) diameter sizes
- Mounting hardware for panel mounted gauges included

### Applications

The 142 AP Pressure Gauges are generally used in applications such as air compressor stations and central control panels.

H-7

Auxiliary Equipment

## Pressure Gauge Specifications

**Accuracy** ..... 2-1/2% of full scale for middle half of the scale, 3-1/2% elsewhere  
**Connection** ..... 1/8" NPT male or barbed connector for 1/4" (6 mm) O.D. tubing

**Shipping Weights**  
 1-1/2" ..... 0.5 lb. (0.23 kg)  
 2-1/2" ..... 1.0 lb. (0.45 kg)  
 3-1/2" ..... 1.3 lb. (0.59 kg)

For more information on receiver gauges, refer to the Controllers and Transmitters, Section C.

## Pressure Gauge Product Ordering

Range	Description	Part No.	
		1-1/2"	2-1/2"
<b>English</b>			
0 to 30 psi	Barb panel	<b>142-0274</b>	<b>142-0277</b>
0 to 30 psi/0 to 200 kPa	NPT male-bottom	<b>142-0426</b>	—
0 to 200 kPa/0 to 30 psi	NPT male-back	<b>142-0373</b>	<b>142-0311</b>
0 to 100 psi	NPT male back-panel	—	—
0 to 100 psi	NPT male back-pipe	—	—
0 to 160 psi	NPT male-back-pipe	—	—
<b>Metric</b>			
0 to 206.8 kPa	Barb	<b>142-0331</b>	—
0 to 206.8 kPa	Pipe	<b>142-0344</b>	<b>142-0371</b>

**Table Note**

Hole sizes for panel mounted gauges are: 1-1/2"/1-11/16"; 2-1/2"/2-21/32" and 3-1/2"/3-11/16" (Gauge Size/Hole Size).

### Siemens Warranty

Most products you purchase from us are backed with a two-year warranty from the date of manufacture. Variable Frequency Drives carry an 18-month product warranty from their date of shipment. VFD's carry a 3-year warranty when a certified start-up is performed. Contact your Account Executive for more information.



## External Restrictors



Tee Barbed Restrictor.



In-line Threaded Restrictor.



In-line Barbed Restrictor.

### Description

Restrictors are available in a variety of orifice sizes and connection types.

### Features

#### External Types 1, 2 and 3

- Air filter
- 1/8-inch NPT threaded connection (Type 1)
- Barbed connection for 1/4-inch (6 mm) plastic tubing (Types 2 and 3)
- Color-coded (Types 2 and 3)
- Air flow direction arrow to minimize installation errors
- Air flow restrictor capacity molded (Types 2 and 3) or stamped (Type 1) on body

### Applications

External restrictors are used:

- For 1-pipe room thermostats, 20 scim (5.5 ml/s), refer to Figure 3.
- For 1-pipe transmitters, 40 scim (11 ml/s), refer to Figures 1 and 2.
- When installed tubing lengths exceed maximum recommended values, refer to Figure 2.
- With check valves to provide air flow time delays:
  - Slow to supply, fast to exhaust, refer to Figure 4.
  - Fast to supply, slow to exhaust, refer to Figure 5.
- VAV vortex control. Use 80 scim (22 ml/s) restrictor in positioning relay control pressure line to prevent cycling.
- When other air capacities, 10 scim (2.7 ml/s), 80 scim (22 ml/s), or 320 scim (87 ml/s) are required to compensate for tubing size or response time.

Figures are on page H-11.



### Typical Connections

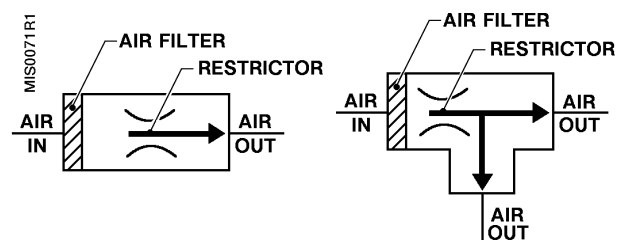

# Restrictor Specifications

## Materials

Type 1..... Brass  
 Type 2 and 3..... Plastic

## Air Connections

Type 1..... 1/8" NPT thread  
 Type 2 and 3..... Barb for 1/4" (6 mm) OD polyethylene tubing

## Ambient Temperature

Minimum..... 40°F (4°C)  
 Maximum..... 140°F (60°C)

## Mounting

..... In-line

## Flow Capacity at Various Air Pressure Drop

Air Pressure	% of Max. Flow Capacity	Nominal Capacity				
		10	20	40	80	320
22 psi (152 kPa)	100%	10 scim (2.7 ml/s)	20 scim (5.5 ml/s)	40 scim (11 ml/s)	80 scim (87 ml/s)	320 scim (87 ml/s)
10 psi (69 kPa)	70%	7 scim (1.9 ml/s)	14 scim (3.8 ml/s)	28 scim (7.6 ml/s)	56 scim (15 ml/s)	224 scim (61 ml/s)
5 psi (34 kPa)	50%	5 scim (1.4 ml/s)	10 scim (2.7 ml/s)	20 scim (5.5 ml/s)	40 scim (11 ml/s)	160 scim (44 ml/s)
2.5 psi (17 kPa)	35%	3.5 scim (1.0 ml/s)	7 scim (1.9 ml/s)	14 scim (3.8 ml/s)	28 scim (7.6 ml/s)	112 scim (31 ml/s)

## Restrictor Product Ordering

Nominal Air Capacity	Orifice Diameter	Part No.			Barbed Restrictor Body Color
		Type 1 In-line Threaded (Pkg. of 1)	Type 2 In-line Barbed (Pkg. of 5)	Type 3 Tee Barbed (Pkg. of 5)	
10 scim (2.7 ml/s)	0.0035" (0.09 mm)	—	184-115	184-112	Red
20 scim (5.5 ml/s)	0.0051" (0.13 mm)	184-040	184-116	184-113	Yellow
40 scim (11 ml/s)	0.0074" (0.19 mm)	184-041	184-117	184-114	Green
80 scim (22 ml/s)	0.0098" (0.25 mm)	184-042	—	—	—
320 scim (87 ml/s)	0.0201" (0.51 mm)	184-052	—	—	—

If inoperative, replace the unit.

## Dimensions

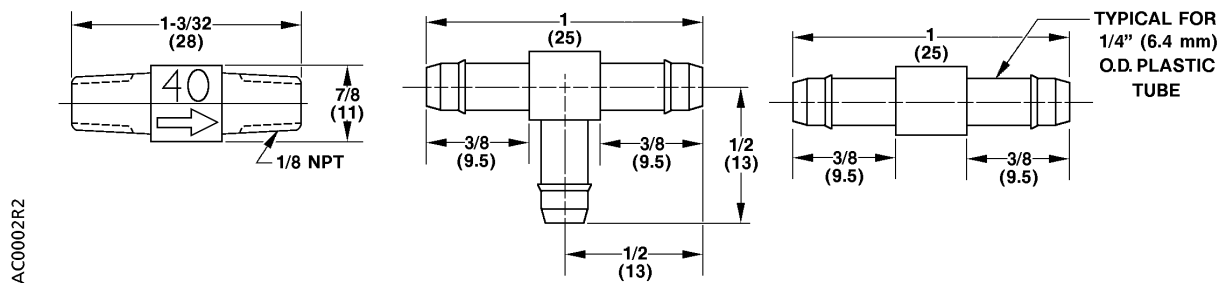

Dimensions shown in inches (mm).

AC0002R2

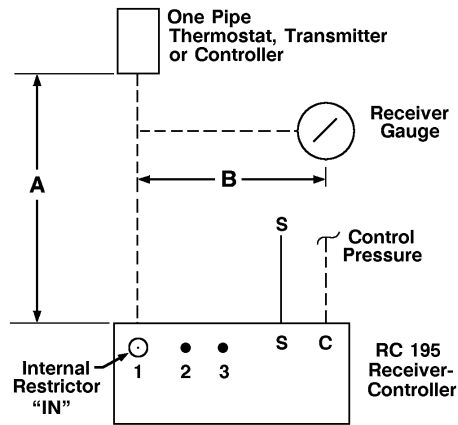

Figure 1.

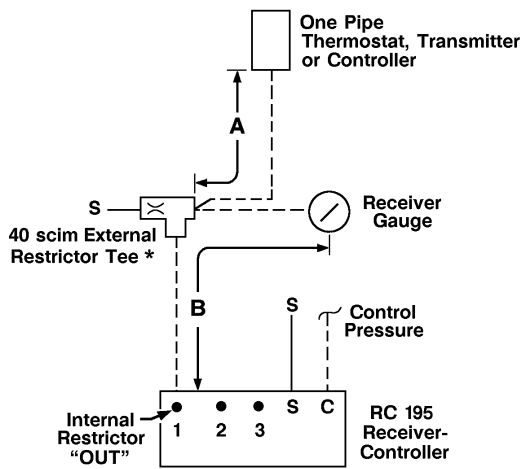

Figure 2.

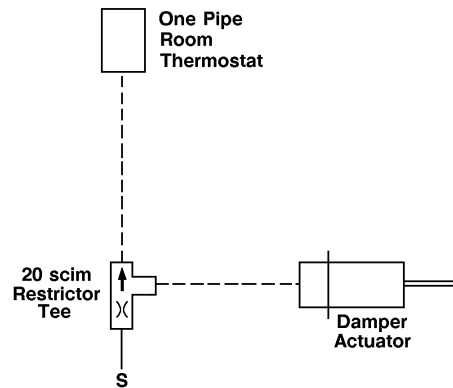

Figure 3.

\* Use External Restrictor with RC195 when "A" length exceeds 300 ft. (91 m) or when "A & B" length exceeds 1,000 ft. (305 m).

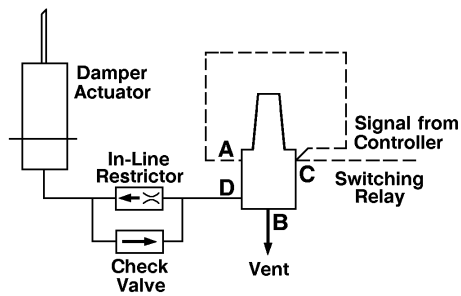

Figure 4.

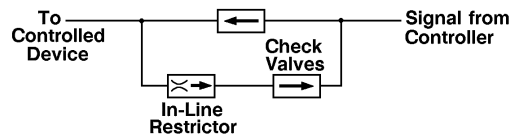

Figure 5.

## Get the latest product news!

Join our e-mail list to receive our quarterly newsletter and other offers that will help your business grow and keep your customers happy. We respect your privacy. Your email address will not be shared with others, it's simply our way of keeping you informed!

**Send us an email at [hvacinquiries.us.sbt@siemens.com](mailto:hvacinquiries.us.sbt@siemens.com) to add your name to the list.**



## Pneumatic Tube Fitting Kit



141-0601 Pneumatic Tube Fitting Kit.



141-464 Case.

### Description

The Pneumatic Tube Fitting Kit provides the service or installation mechanic with a compact and convenient source of the most commonly used brass barbed fittings for 1/4-inch (6 mm), 3/8-inch (10 mm) and 1/2-inch (13 mm) OD polyethylene tubing.

### Features

- Rustproof, odor and oil resistant case
- Translucent lid for easy identification of fittings
- Double positive latches
- 15 dividers for configuring up to 24 compartments
- Lower cost for fittings
- Representative quantities of commonly used 1/4-inch (6 mm), 3/8-inch (10 mm) and 1/2-inch (13 mm) brass fittings

### Applications

The Pneumatic Tube Fitting Kit is useful for servicing, modifying, or adding to pneumatic control systems. Purchasing in quantity reduces material costs. Labor savings is the major reason to have this convenient kit in your service shop or van.

H-13

Auxiliary Equipment







# Pneumatic Tube Fitting Kit Specifications

Case Material ..... Copolymer Resin  
 Dimensions ..... 15" L x 11.75" W x 2.5" D  
 (381 mm L x 298 mm W x 64 mm D)  
 Shipping Weight  
 Case ..... 3.0 lb. (1.4 kg)  
 Case and Fittings ..... 7.0 lb. (3.2 kg)

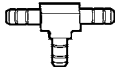
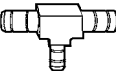
## Other Supplies and Equipment

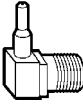
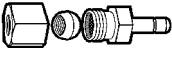
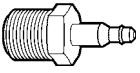
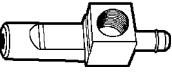
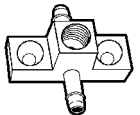
The fittings in this kit represent most of the commonly used polyethylene tube fittings required by HVAC mechanics.

## Kit Includes:

	Description	Quantity
	<b>Barbed Tee.</b> • 1/4" (6 mm) • 3/8" (10 mm) • 1/2" (13 mm)	12 6 6
	<b>1/4" (6 mm) Barbed Reducing Tee.</b> • 3/8" (10 mm) • 1/2" (13 mm)	6 6
	<b>90° Elbow.</b> • 1/4" (6 mm) • 3/8" (10 mm) • 1/2" (13 mm)	12 6 6
	<b>1/8" NPT Male x 90° Elbow.</b> • 1/4" (6 mm) or 5/32" (4 mm)	12
	<b>1/4" (6 mm) OD Copper Coupling.</b> • 1/4" (6 mm)	10
	<b>1/8" NPT Male.</b> • 1/4" (6 mm)	10
	<b>Gauge Tee 1/8" NPT Male/NPT Female.</b> • 1/4" (6 mm)	10
	<b>Gauge Tee 1/8" NPT Female.</b> • 1/4" (6 mm)	5
	<b>Plug.</b> • 1/4" (6 mm)	10
	<b>Reducer Coupling OD.</b> • 1/4" (6 mm)	10
	<b>Coupling.</b> • 1/4" (6 mm ) • 3/8" (10 mm) • 1/2" (13 mm)	12 10 10

## Pneumatic Tube Fitting Kit Product Ordering

Description	Part No.
Complete Kit with 159 fittings	<b>141-0601</b>
Case only	<b>141-464</b>

H-14

Auxiliary Equipment

## Controls Cabinet/Enclosure



567-351 Exposed Panel Assembly.

### Description

Designed to conveniently group control system components, 567 Controls Cabinets are available in two styles, exposed and flush mount.

With the exposed panels, the control components can be mounted in the door or mounted within the enclosure using the perforated panel. The cabinet housing, door, and perforated mounting plate may be ordered as a unit or separately.

The flush mount panel is designed to recess the panel into a wall. The controls are mounted within the enclosures on a perforated panel. Order both the cabinet and the mounting kit.

### Features

- Panels are symmetrical, and can be mounted with door hinge on left or right-hand side
- Removable door with lock and keys
- Removable perforated subpanel permits mounting controls without drilling holes
- Attractive gray finish permits use in occupied areas
- Support kit is available for floor mounting (medium and large exposed cabinets only)
- Variety of mounting methods available
- Knockouts are provided for electrical or pneumatic piping
- Panels listed under UL508 Industrial Control Panel Enclosures
- CSA listed under LR 84214
- NEMA Type 1
- Exposed Panels available in 6" or 9" depth

### Applications

The 567 Controls Cabinets provide a convenient central location for equipment mounting, termination of piping, wiring adjustment, and calibration.

Panels may be used with DDC and/or pneumatic systems using either copper or polyethylene tubing for transmission lines, with wired electric/electronic systems, or with a combination of both. Within the panel enclosure, use polyethylene pneumatic tubing for easy installation and arrangement and for a flexible connection to hinged door components.

The empty panel can be installed at the job to permit early rough-in of conduit. Since the door and subpanel can be separated from the cabinet, controls may be mounted to the door subpanel either at the job site or at the field office and connected to the cabinet at your convenience. After reassembly, final connections are then made.

H-15

Auxiliary Equipment

# 567 Controls Cabinet Specifications

## Exposed Panel

### Dimensions — 9" Depth

Size 3: ..... 24.94" H x 24.38" W x 9.38" D  
 (633 mm H x 619 mm W x 238 mm D)  
 Size 4: ..... 36.5" H x 24.38" W x 9.38" D  
 (927 mm H x 619 mm W x 238 mm D)

### Dimensions — 6" Depth

Size 1: ..... 19.5" H x 16.38" W x 5.75" D  
 (495 mm H x 416 mm W x 146 mm D)  
 Size 2: ..... 20.0" H x 20.0" W x 6.0" D  
 (508 mm H x 508 mm W x 152 mm D)  
 Size 3: ..... 24.94" H x 24.38" W x 6.0" D  
 (633 mm H x 619 mm W x 152 mm D)  
 Size 4: ..... 36.5" H x 24.38" W x 6.0" D  
 (927 mm H x 619 mm W x 152 mm D)

### Shipping Weights — 9" Depth

Size 3: ..... 39.0 lb. (18 kg)  
 Size 4: ..... 72.0 lb. (33 kg)

### Shipping Weights — 6" Depth

Size 1: ..... 20.0 lb. (9 kg)  
 Size 2: ..... 28.0 lb. (13 kg)  
 Size 3: ..... 38.0 lb. (17 kg)  
 Size 4: ..... 63.0 lb. (29 kg)

## Flush Mount Panel — 567-391

Dimensions ..... 19.5" H x 16.13" W x 5.13" D  
 (495 mm H x 410 mm W x 130 mm D)

Shipping Weight ..... 20.0 lb. (9 kg)

## Panel Door

### Shipping Weights

Size 1: ..... 8.0 lb. (3.6 kg)  
 Size 3: ..... 13.0 lb. (5.9 kg)  
 Size 4: ..... 20.0 lb. (9 kg)

H-16

Auxiliary Equipment

## 567 Controls Cabinet Product Ordering

Size	Part No. — 9"	Part No. — 6"
<b>Exposed Panel Assembly</b>		
Size 1	—	<b>567-351</b>
Size 2	—	<b>567-454</b>
Size 3	<b>567-352</b>	<b>567-452</b>
Size 4	<b>567-353</b>	<b>567-453</b>
<b>Panel Door Only</b>		
Size 1	<b>567-361</b>	—
Size 3	<b>567-362</b>	—
Size 4	<b>567-363</b>	—
<b>Panel Enclosure</b>		
Size 1	<b>567-371</b>	—
Size 3	<b>567-372</b>	—
Size 4	<b>567-373</b>	—
<b>Mounting Plate Only</b>		
Size 1	<b>567-381</b>	—
Size 3	<b>567-382</b>	—
Size 4	<b>567-383</b>	—
<b>Flush Mount Panel &amp; Kit</b>		
Flush Mount Panel	<b>567-391</b>	—
Flush Mount Kit contains escutcheon, hinged locking door and two keys	<b>567-390</b>	—



## Accessories & Service Kits H-19



Part No. in black box Ships same day when requested through Rapid Response™ shipping. See inside back cover for details.

